

Proudly Distributed By

TRIDENT AUSTRALIA
FLUID SYSTEMS & COMPONENTS



ENERPAC 

XC-SERIES CORDLESS HYDRAULIC PUMPS

EXTREME PERFORMANCE, CORDLESS CONVENIENCE



XC-Series, Cordless Hydraulic Pump

ENERPAC 

▼ Shown: XC1201ME



- Lightweight design with integrated handle and carrying strap for portability
- Bladder reservoir prevents contamination and allows pump usage in any position
- Powerful 0,37 kW motor and 28-volt Lithium-Ion battery deliver exceptional speed and run time
- High-strength fiberglass reinforced composite shroud for superior durability in demanding job site environments
- Cordless technology eliminates tripping hazards found in other electric or air powered pumps
- Available in torque wrench, dump and hold, single-acting and double-acting valve configurations



Performance of a Powered Pump Portability of a Hand Pump



GA45GC Gauge Adaptor

Protect yourself from system overloading by simply ordering one part number for a pre-assembled gauge, adaptor block and coupler.



28-Volt Battery

The XC28V with Lithium-Ion technology for maximum battery performance.



Battery Charger

1-hour quick charger.

XC115VC	115 VAC
XC230VC	230 VAC



Interactive Pendant

An interactive pendant is available on the **XC1302S** dump and hold models and **XC1502T** torque wrench models. Operation, programming, and diagnostic status are provided to the user with yellow, green, and red LED as well as vibration pulses. The **XC1302S** models can easily toggle between "jog operation" to "dump system pressure" and the **XC1502T** models allow "manual" and "auto cycle" mode.

◀ Power and simplicity for the toughest jobs.

Cordless Hydraulic Pump



XC-Series Cordless Hydraulic Pump

The XC-Series cordless pump is ideal for jobs that require a combination of portability, speed, and safety. These cordless pumps are perfect for remote locations without access to power, but also indoors where trip hazards, ergonomics or size is a concern. The XC-Series cordless pump is compatible with all Enerpac hydraulic tools and small to medium sized cylinders.

The Lithium-Ion battery provides superior run time.*

- 279 cuts of 10 mm reinforcing bar using the WHC-750 Cutter
- 112 lifts with the WR-5 Spreader
- 44 splits on M27-8.8 nuts using the NC-3241 Nut Splitter
- 28 lifts of an RC-104

*Actual number of cycles per charge will vary depending on condition of tool, battery and ambient conditions. Battery life with double-acting tools is approximately 75% of that for comparable, single-acting tools.

XC Series



Reservoir Capacity:
1,0 - 2,0 litres

Flow at Rated Pressure:
0,25 l/min

Maximum Operating Pressure:
700 bar

- 1 Outlet "Advance" Port
- 2 Oil Fill (*must use funnel*)
- 3 User Adjustable Relief Valve Access Port
- 4 Directional Control Valve *
- 5 Shoulder Strap Connection Points
- 6 Safety Lock Feature *
- 7 On/Off Switch *
- 8 Inlet "Retract" Port (double-acting models only)

* Single-acting and double-acting models only

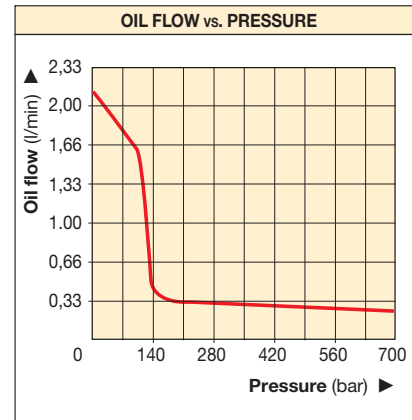
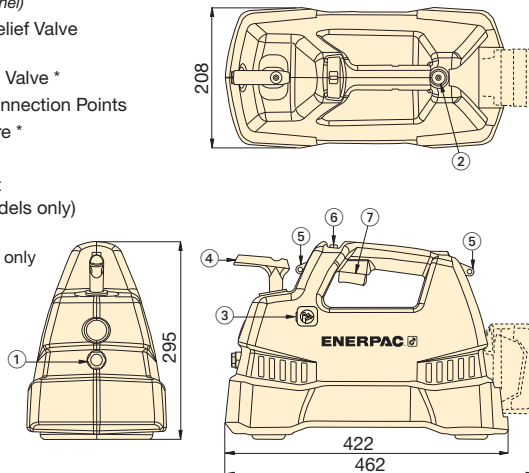

Oil Capacity (l)	Model Number	Output Flow Rate (l/min)			Valve Function	Charger Voltage (VAC)	Weight (includes oil and battery) (kg)	
		No Load	140 bar	700 bar				
1,0	XC1201MB	2,0	0,50	0,25	3-way, 2-pos.	115	10	
2,0	XC1202MB	2,0	0,50	0,25			11	
1,0	XC1201ME	2,0	0,50	0,25	3-way, 2-pos.	230	10	
2,0	XC1202ME	2,0	0,50	0,25			11	
1,0	XC1201M*	2,0	0,50	0,25	3-way, 2-pos.	-	9	
2,0	XC1202M*	2,0	0,50	0,25			10	
2,0	XC1302SB	2,0	0,50	0,25	Dump and Hold	115	11	
2,0	XC1302SE	2,0	0,50	0,25			230	11
2,0	XC1302S*	2,0	0,50	0,25			-	10
1,0	XC1401MB	2,0	0,50	0,25	4-way, 3-pos.	115	10	
2,0	XC1402MB	2,0	0,50	0,25			11	
1,0	XC1401ME	2,0	0,50	0,25	4-way, 3-pos.	230	10	
2,0	XC1402ME	2,0	0,50	0,25			11	
1,0	XC1401M*	2,0	0,50	0,25	4-way, 3-pos.	-	9	
2,0	XC1402M*	2,0	0,50	0,25			10	

* Batteries and charger not included.

▼ Take the battery pump anywhere without power cords or air hoses.





XC-Series, Cordless Torque Wrench Pump **ENERPAC**

▼ Shown: XC1502TE



Portable Battery Pump for Torque Applications

- Ideal for maintenance bolting applications requiring portability and convenience
- Interactive pendant provides visual and vibratory feedback of pump operation
- User can set pressure and operate in manual or auto cycle mode
- Superior run-time with 5Ah, 28V battery
- Brushless DC motor extends motor life and reduces maintenance
- 6 m detachable pendant control, with option to use trigger control as well
- 100 mm glycerin-filled gauge for easy viewing
- User-adjustable relief valve can be locked when desired pressure is set

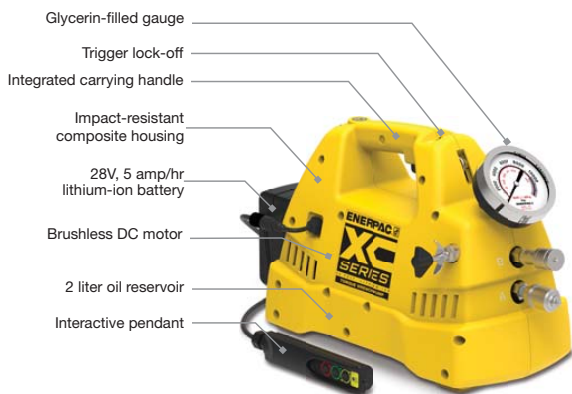

28-Volt Battery

The XC28V5 with Lithium-ion technology for maximum battery performance.



Battery Charger

1-hour quick charger.

XC115VC	115 VAC
XC230VC	230 VAC



Roll Cage

A roll cage accessory is available for all XC models. Please order model number XCRCTK.



Torque Wrenches

The following wrenches are ideal for use with the XC Cordless Torque Wrench Pump:

<u>S-Series</u>	<u>W-Series</u>	<u>RSL-Series</u>
S1500X	W2000X	RSL1500
S3000X	W4000X	RSL3000

Larger wrenches will work with the pump, battery run time and application speed will be impacted.



Proudly Distributed By

TRIDENT AUSTRALIA
FLUID SYSTEMS & COMPONENTS

Cordless Torque Wrench Pump



The XC-Series Cordless Torque Wrench pump is ideal for maintenance applications in the PowerGen, Oil & Gas and MRO markets. This portable pump is perfect for remote locations, sites that do not have access to power or where trip hazards are a concern.

The interactive pendant allows the user to set and clear pressure and operate in manual or auto-cycle mode.

The pump has an easily accessible user adjustable valve for precise pressure control.

Fasteners Torqued On One Charge

Torque Wrench	Nut AF (mm)	Stud (mm)	Pressure (bar)	Torque (Nm)	Fasteners Torqued
S3000X	60	38	330	2035	32
W2000X	60	38	350	1356	52

XC Series



Useable Oil Capacity:
2,0 litres

Flow at Rated Pressure:
0,25 l/min

Motor Size:
0,37 kW

Maximum Operating Pressure:
700 bar

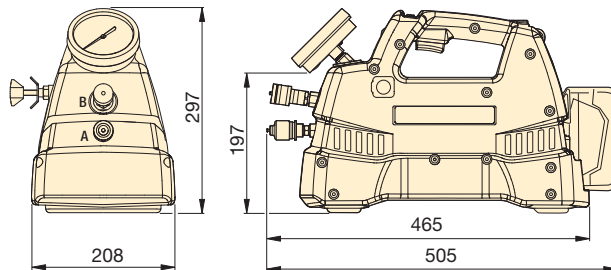
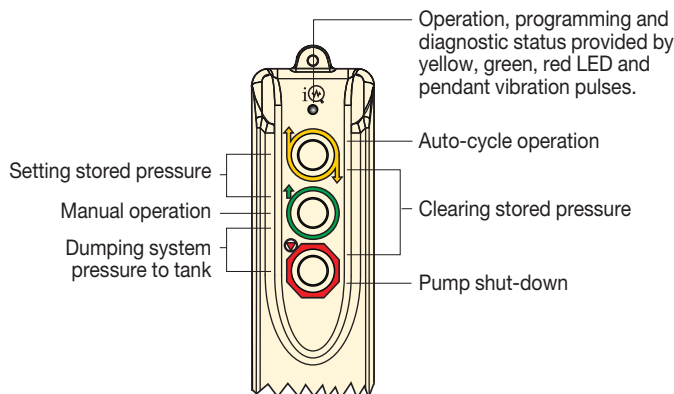

Twin Torque Wrench Hoses

Use Enerpac THQ700 series twin hoses with 700 bar pumps.

2 m long, 2 hoses	THQ702T
6 m long, 2 hoses	THQ706T
12 m long, 2 hoses	THQ712T

OIL FLOW vs. PRESSURE

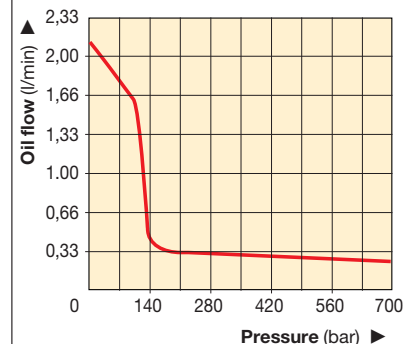

Pump Type	Useable Oil Capacity (l)	Model Number	Output Flow Rate (l/min)			Included with Pump	Weight (includes oil and battery) (kg)
			No Load	140 bar	700 bar		
Cordless Pump Kit	2	XC1502TB	2,05	0,49	0,25	2 batteries and 115V charger	13,1
Cordless Pump Kit	2	XC1502TE	2,05	0,49	0,25	2 batteries and 230V charger	13,1
Cordless Pump	2	XC1502T*	2,05	0,49	0,25	No batteries or charger	12,0

* Batteries and charger not included.

System Accessories



▼ Shown from top to bottom: HC-7206, HC-7210



Thermo-plastic Hoses (700-Series)

- For demanding applications, featuring a 4:1 design factor
- Two layers of steel wire braids
- Outside jacket is polyurethane, to provide maximum abrasion resistance

Emphasize Safety and Quality



To ensure the integrity of your system, specify only Enerpac hydraulic hoses.

WARNING !

- Do not exceed 700 bar (10,000 psi) maximum pressure.
- Do not handle hoses while under pressure.

▼ Shown: GA45GC



GA45GC

- Pre-assembled gauge, adaptor block and coupler
- 45° angled gauge improves visibility
- Slim and narrow design
- Glycerin dampened gauge with dual scale



Hoses

Recommended for use with the XC-Series Pumps.

Thermo-plastic	
2 m long	HC7206
3 m long	HC7210



C-604 High Flow Coupler

Recommended for use with the XC-Series Pumps (not the XCTW Bolting Series Pumps).



CT-604 Safety Tool

Use the Enerpac CT-604 to relieve hydraulic back pressure by safely bleeding the hydraulic coupler.

Minimize injuries from projectile parts and under-skin hydraulic fluid injections by eliminating unsafe coupler bleeding practices. The CT-604 is Enerpac-engineering safe for use at 700 bar (10,000 psi).

NOTE: C-Series only.

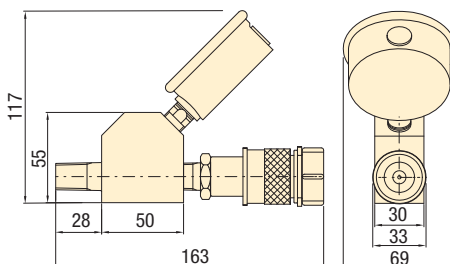

Tool Solutions

Enerpac offers a variety of tools that are ideal to use with the portable and lightweight XC-Series Pumps.

Whatever your requirement—lifting, pressing, cutting, punching, spreading, tightening or bending; you can be sure that Enerpac has the correct tool to do your job safely and efficiently.

INDUSTRIAL TOOLS



Cylinders



Cutters



Punches



Pullers



Lifting Wedges



Benders



Spreaders

BOLTING TOOLS



Torque Wrenches



Flange Alignment Tools



Pump Sets

Pump sets with cylinders (general purpose, low-profile, and hollow) and nut splitters are also available for the XC-Series. A set includes the tool, XC102MB, gauge, hose, and case*.

Tool Model Number	XC-Series Set Model Number
RC102	SCR-102XCB
RC106	SCR-106XCB
RC1010	SCR-1010XCB
RC154	SCR-154XCB
RC156	SCR-156XCB
RC252	SCR-252XCB
RC254	SCR-254XCB
RC256	SCR-256XCB
RCS302	SCL-302XCB
RCS502	SCL-502XCB
RCS1002	SCL-1002XCB
RCH202	SCH-202XCB
RCH302	SCH-302XCB
RCH603	SCH-603XCB
NS70105	NS70105SCB
NS11013	NS110130SCB

*Only the nut splitter set includes a case.



Proudly Distributed By

TRIDENT AUSTRALIA
FLUID SYSTEMS & COMPONENTS

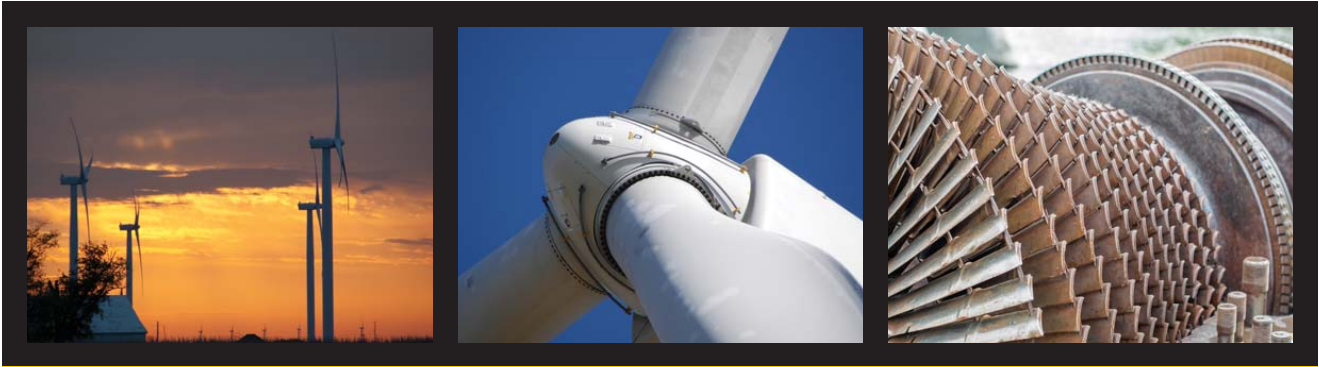

HYDRAULIC PUMPS

Enerpac hydraulic pumps are available in over 1000 different configurations. Whatever your application needs are for speed, control, intermittent or heavy-duty, Enerpac has the right solution for you. Featuring Hand, Battery, Electric, Air and Gasoline-powered models, Enerpac offers the most comprehensive pump line available.

Industrial Tool Pumps



ZU-Series,
Electric



ZE-Series,
Electric



XA-Series,
Air



ZC-Series,
Cordless



E-Series,
Electric



XC-Series,
Cordless

Torque Wrench Pumps



TQ-700 Series,
Electric



ZA4T-Series,
Air



ZU4T-Series,
Electric



ZE-T Series,
Electric



E-Series,
Electric



XC-Series,
Cordless

YOUR ENERPAC DISTRIBUTOR:

ENERPAC

www.enerpac.com

ENERPAC

SIMPLEX

LARZEP
HYDRAULIC

biach

EQUALIZER
INTERNATIONAL

MIRAGE

SWEENEY

hydratight

753_03-030147019_EN-AU © 2019 Enerpac - Subject to change without notice.

Ph: +61 8 9456 1300

Web: www.tridentaustralia.com.au

Email: sales@tridentaustralia.com.au