



GF, GP-Series, Hydraulic Force & Pressure Gauges



▼ Shown from left to right: GF-230B, GF-835B, GP-10S



- **GF-series gauges:** calibrated with dual scale reading for pressure in bar and force in kN
- **GF-series gauges:** all pressure sensing parts are sealed and dampened by glycerine for long life
- **GP-series gauges:** calibrated with dual scale reading for pressure in bar and psi
- **Excellent readability:** gauge face dimensions 100 mm
- **Fast, easy installation**
- **Stainless steel gauge cases for corrosion resistance.**

▼ A GP-10S gauge is used on this press to check the hydraulic pressure required to bend flat steel bar.



Visual Reference for System Pressure and Force



Auto-Damper Valve V-10

For automatic control of gauge fluctuations, the V-10 Auto-Damper Valve controls the movement of the gauge needle by restricting oil flow in and out of the gauge. No adjustments needed.

Page: 128



Snubber Valve V-91

Infinitely adjustable for metering oil out of a gauge. The V-91 Snubber Valve is also suitable as a shut-off valve to protect the gauge during high cycle applications.

Page: 128

Used With Cylinders

	All Cylinders
	All Cylinders
	5 ton RC, RSM Cylinders
	10 ton RC, RCS, RSM Cylinders
	All 25 ton RC-Cylinders
	All 50 ton RC, RR-Cylinders
	13 ton RCH-Series
	RCS-201, 302
	RCS-502, 1002
	RCH-202, 302, 603
	25, 30, 50 ton RC, RCS, RSM, RR
	All 75 and 95 ton RC, RR
	All 150, 200 ton RR cylinders
	10 ton Presses
	25 ton Presses
50 ton Presses	
75 and 100 ton Presses	
150 and 200 ton Presses	



Proudly Distributed By

TRIDENT AUSTRALIA
FLUID SYSTEMS & COMPONENTS

Hydraulic Force & Pressure Gauges



Maximum Indicator Pointer

Indicator retains peak readings of pressure or force generated by the system.

Can easily be installed on GP and H-Series gauges.

Order model number: **BSA-881**.



Pressure Gauges

To measure the input pressure into cylinders or high pressure systems. Also for all testing applications.

Force Gauges

To measure external load supported by a cylinder or jack in kN. For pressing parts together under pre-determined loads, weighing, testing, etc.

GP-Series are dry gauges.

GF-Series are glycerine filled gauges.

GF GP Series



Pressure Range:

0 - 1000 bar

Force Range:

0 - 2000 kN

Gauge Face Diameter:

100 mm

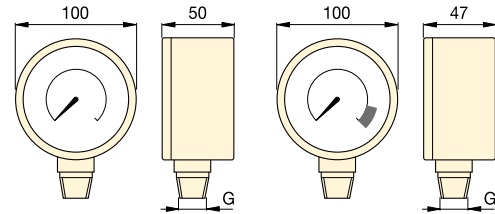

Accuracy, % of full scale:

± 1%



GP-serie

GF-serie

Gauge Type and Calibration				Units per Division	Model Number *	Thread G	Gauge Adaptor		
							 127		
bar	psi	bar	kN ¹⁾				GA-1	GA-2	GA-3
0-700	0-10.000	-	-	10 bar, 100 psi	GP-10S	1/2" NPTF	●	●	
0-1000	0-15.000	-	-	10 bar, 200 psi	GP-15S	1/2" NPTF	●	●	
-	-	0-700	0-45	10 bar, 0,5 kN	GF-5B	1/2" NPTF	●	●	
-	-	0-700	0-100	10 bar, 1 kN	GF-10B	1/2" NPTF	●	●	
-	-	0-700	0-232	10 bar, 2 kN	GF-20B	1/2" NPTF	●	●	
-	-	0-700	0-500	10 bar, 5 kN	GF-50B	1/2" NPTF	●	●	
-	-	0-700	0-124	10 bar, 1 kN	GF-120B	1/2" NPTF	●	●	
-	-	0-700	0-175/275	10 bar, 2 + 5 kN	GF-230B	1/2" NPTF	●	●	
-	-	0-700	0-450/900	10 bar, 5 + 10 kN	GF-510B	1/2" NPTF	●	●	
-	-	0-700	0-210/320/570	10 bar, 5 kN	GF-813B	1/4" NPTF			●
-	-	0-700	0-232/300/500	10 bar, 5 kN	GF-835B	1/4" NPTF			●
-	-	0-700	0-720/930	10 bar, 10 kN	GF-871B	1/4" NPTF			●
-	-	0-700	0-1400/2000	10 bar, 25 kN	GF-200B	1/4" NPTF			●
-	-	0-700	0-100	10 bar, 1 kN	GF-10B	1/2" NPTF	●	●	
-	-	0-700	0-232	10 bar, 2 kN	GF-20B	1/2" NPTF	●	●	
-	-	0-700	0-500	10 bar, 5 kN	GF-50B	1/2" NPTF	●	●	
-	-	0-700	0-720/930	10 bar, 10 kN	GF-871B	1/4" NPTF			●
-	-	0-700	0-1400/2000	10 bar, 25 kN	GF-200B	1/4" NPTF			●

* GF-Series Force gauges with imperial scale reading (psi, lbs) are available by changing the suffix 'B' into 'P'.

¹⁾ Depending on cylinder model, force indication can deviate.

www.enerpac.com

ENERPAC 121

G, H-Series, Hydraulic Pressure Gauges

ENERPAC 
POWERFUL SOLUTIONS. GLOBAL FORCE.

▼ Shown from left to right: H4049L, G-2534R, G-4089L, G-2535L, G-4040L



Visual Reference of System Pressure



Gauge adaptor assembly

45° Angled gauge adaptor **GA45GC** improves safe working conditions.

Page: 126



Gauge Adaptor

For easy gauge installation into almost any system, Enerpac offers a complete line of gauge adaptors.

Page: 127



Snubber Valve V-91

Infinitely adjustable for metering oil out of a gauge. The V-91 Snubber Valve is also suitable as a shut-off valve to protect the gauge during high cycle applications.

Page: 128

Glycerine Filled (G-Series)

- Dual scale reading calibrated in bar and psi
- All pressure sensing parts sealed and dampened by glycerine for long life
- Includes safety blow-out disk and pressure equalizing membrane
- Gauge snubbers or needle valves recommended for high cycle applications.

High Cycle Dry Gauges (H-Series)

- Dual scale reading calibrated in bar and psi
- Ideal for use in many applications, specifically for high cycle and harsh environments
- Gauge snubbers or needle valves recommended to shut off gauge when not in use.

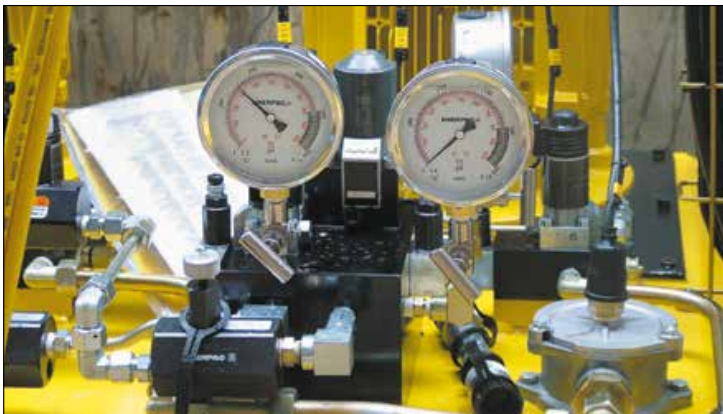

◀ When lifting or pressing, always use a gauge. A gauge is your 'window' to the system. It lets you see what's going on.



Proudly Distributed By

TRIDENT AUSTRALIA
FLUID SYSTEMS & COMPONENTS

Hydraulic Pressure Gauges



CAUTION!
When lifting or pressing,
always use a gauge.

Do not override factory setting of relief valves. Always use a gauge to check system pressure. A gauge is your 'window' to the system. It lets you see what's going on. See our Safety Instructions.

Page: 267

**G
H
Series**



Pressure Range:
0 - 1000 bar

Face Diameter:
63 - 100 mm

Accuracy, % of full scale:
± 1,0 - 1,5%

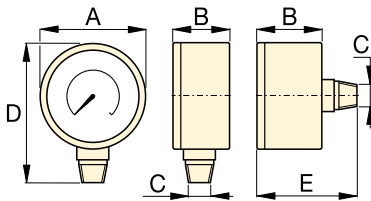

Size (mm)	Connection	Dimensions (mm)				
		A	B	C	D	E
63	Lower Mount	63	37	1/4" NPTF	84	-
63	Center Rear	63	37	1/4" NPTF	-	63
100	Lower Mount	100	29	1/4" NPTF	121	-
100	Lower Mount	100	49	1/2" NPTF	136	-

Note: dimensions for reference only.



Maximum Indicator Pointer

Indicator retains peak readings of pressure or force generated by the system.

Can easily be installed on GP and H-Series gauges. Order model number: **BSA-881**.

▼ SELECTION CHART

Gauge Series	Pressure Range		Model Number				Major Graduation		Minor Graduation		Major Graduation		Minor Graduation	
			ø 63 1/4" NPTF Lower Mount	ø 63 1/4" NPTF Center Rear	ø 100 1/4" NPTF Lower Mount	ø 100 1/2" NPTF Lower Mount	bar		psi		bar		psi	
	(bar)	(psi)	Accuracy: ± 1,5 %		Accuracy: ± 1,0 %		ø 63	ø 100	ø 63	ø 100	ø 63	ø 100	ø 63	ø 100
	G-Series	0-7	0-100	G2509L	-	-	-	1	-	0,01	-	10	-	2
0-11		0-160	G2510L	-	-	-	1	-	0,02	-	10	-	2	-
0-14		0-200	G2511L	-	-	-	1	-	0,02	-	50	-	5	-
0-20		0-300	G2512L	-	-	-	5	-	0,50	-	50	-	5	-
0-40		0-600	G2513L	-	-	-	10	-	1	-	100	-	10	-
0-70		0-1.000	G2514L	G2531R	-	-	10	-	1	-	100	-	20	-
0-140		0-2.000	G2515L	-	-	-	10	-	5	-	500	-	50	-
0-200		0-3.000	G2516L	-	-	-	50	-	5	-	500	-	50	-
0-400		0-6.000	G2517L	G2534R	-	-	100	-	10	-	1000	-	100	-
0-700		0-10.000	G2535L	G2537R	G4088L	G4039L	100	100	10	10	2000	1000	200	100
0-1000	0-15.000	G2536L	G2538R	G4089L	G4040L	100	100	20	20	3000	3000	200	200	
H-Series	0-700	0-10.000	-	-	H4049L	H4071L	-	100	-	10	-	1000	-	100



Proudly Distributed By

TRIDENT AUSTRALIA
FLUID SYSTEMS & COMPONENTS

T-Series, Test System Gauges

ENERPAC
POWERFUL SOLUTIONS. GLOBAL FORCE.

▼ T-6003L



T Series

Pressure Range:
0 - 3500 bar

Face Diameter:
162 - 192 mm

Accuracy, % of full scale:
± 0,5 - 1,5%

- Dual scale reading calibrated in bar and psi
- All gauges have spring-loaded backs with rubber blow-out plugs to protect case assembly in case of over-pressurization
- Integral maximum indicator pointer standard included
- 2800 and 3500 bar models include flange mounting
- ½" NPTF versions are made of high strength alloy steel
- 0.25" cone models are made of 316 stainless steel, with 403 stainless steel on 2800 and 3500 bar models.



Cone Mount Gauge Adaptor
Contains fittings to connect ¼" cone fitting gauge to ⅜" cone system. Kit includes 43-301 tee, 43-704 gauge adaptor and 45-116 tubing. Order model number: **83-011**.

Page: **73**



Cone Mount Gauge Connector
For connecting gauges with 0.25" cone fitting directly to model number **11-100** or **11-400** pump (page 72). May be used with other 0.25" cone systems. Order model number: **43-704**

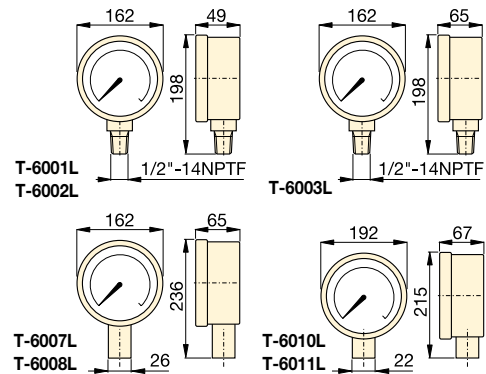

▼ An Enerpac P-2282 hand pump equipped with a T-6011L test system gauge is used for proof pressure testing of hydraulic valves.



Pressure Range (bar)	Pressure Range (psi)	Model Number		Number Intervals (bar)	Graduation Intervals (bar)	Number Intervals (psi)	Graduation Intervals (psi)
		Alloy Steel ½" NPTF	Stainless Steel 0,25 cone				
0-70 ¹⁾	0-1000	T-6001L	-	10	1	100	10
0-350 ¹⁾	0-5000	T-6002L	-	50	5	500	50
0-700 ¹⁾	0-10.000	T-6003L	T-6007L	100	10	1.000	100
0-1400 ¹⁾	0-20.000	-	T-6008L	200	20	1.000	100
0-2800 ²⁾	0-40.000	-	T-6010L	500	20	5.000	200
0-3500 ²⁾	0-50.000	-	T-6011L	500	50	5.000	200

¹⁾ Accuracy ± 0,5%

²⁾ Accuracy ± 1,5%

Digital Hydraulic Pressure Gauge

▼ DGR-2



- Rated for system pressure up to 1380 bar
- Displays in bar, psi, MPa and kg/cm²
- Zero reset - ensures that gauge reads actual pressure
- IP65 protection, UL listed, CE and RoHS compliant
- Batteries included, condition indicator on read-out
- Shut-off selectable – menu driven
- Back-lit readout allows easy reading in less than ideal lighting
- Protective cover included.

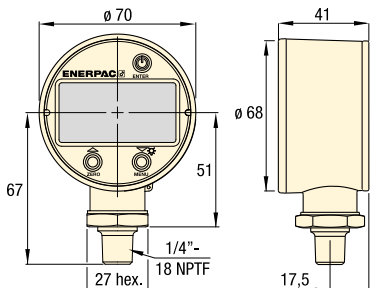

High Pressure Rating (bar)		High Pressure Rating (MPa)		Model Number	High Pressure Rating (psi)		High Pressure Rating (kg/cm ²)	
Range	Resolution	Range	Resolution		Range	Resolution	Range	Resolution
0-1380	0,1	0-140	0,01	DGR-2	0-20.000	1	0-1400	0,1

Weight: 0,23 kg.

www.enerpac.com

DGR Series

Pressure Range:
0 - 1380 bar

Voltage:
3 Volt (battery)

Accuracy, % of full scale:
± 0,25%



Gauge Adaptor

For easy gauge installation into almost any system, Enerpac offers a complete line of gauge adaptors. Maximum operating pressure 700 bar.

Page: 127

▼ Greater accuracy and easier to read: enhance your ability to monitor and control hydraulic system pressure up to 1380 bar.



ENERPAC 125



Gauge Adaptor Assembly

ENERPAC
POWERFUL SOLUTIONS. GLOBAL FORCE.

▼ Shown: GA45GC



GA45GC Series

Connection 1:
3/8" NPTF male

Connection 2:
CR-400 coupler

Maximum Operating Pressure:
700 bar

45° Angled gauge adaptor improves safe working conditions

- 45° angled gauge improves visibility
- Slim and narrow design
- Easy to fit in a broad range of systems
- Maximize controlled load movement
- Glycerin dampened gauge with dual scale
- Enerpac High Flow female coupler.



CAUTION!
Always use a gauge.

Do not override factory setting of relief valves. Always use a gauge to check system pressure. A gauge is your 'window' to the system. It lets you see what's going on. See our Safety Instructions.

Page: 267



Power Box

Tool box with hand pump, GA45GC gauge adaptor assembly, hose and RC, RSM, RCS, WR5 or LW16-cylinder.

Page: 55

▼ The Gauge Adaptor Assembly is the window to your system; allows easy reading of the pressure for safe operation.

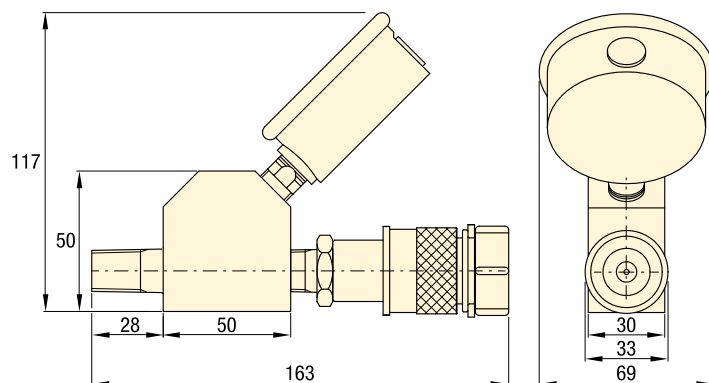

Model Number	Gauge Port (1/4" NPTF)	Male End (NPTF)	Female End (3/8" NPTF)	Gauge Range	
				(bar)	(psi)
GA45GC	G2535L	3/8" -18	CR-400	0 - 700	0 - 10.000