



Fittings and Tubing

Medium Pressure Cone & Thread

Pressures to 20,000 psi (1379 bar)
Includes Check Valves, Filters & Couplings



Principle of Operation:

Parker Autoclave Engineers Medium Pressure Cone and Thread connections were created for those applications that require higher flow rate capability. Designed for a maximum of 20,000 psi MAWP using high tensile strength cold worked 316 Stainless Steel material as standard. In addition we offer even larger ID tubing de-rated to 15,000 psi for maximum flow rate capability. This Medium Pressure series has all the benefits of the High-Pressure version with all metal sealing, temperature ranges from -423° to 1200°F (-252° to 650°C), and includes many different material options like 2507 Super Duplex, Hastelloy C276, 6Mo (25-4SMO), and Inconel 625 to mention just a few.

Fittings and tubing found in this section are designed using ASME B31.3 Chapter IX standards to be compatible with our 15SM & 20SM, 20DBNV, 20DV Needle Valves, and all of our various ball valve configurations including Subsea. There is a Parker Instrumentation fitting for just about any application of fluids under extreme pressure and/or temperature condition.

Medium Pressure Fittings and Tubing Features:

- Utilize “SF” Style High Flow Medium Pressure Coned-and-Threaded connections (see Tools and Installation for typical port dimensions)
- Available sizes are 1/4", 3/8", 9/16", 3/4", 1" and 1-1/2"
- Standard Fitting Material is UNS S31600 with Tubing manufactured using UNS S31600/S31603, 316/316L stainless steel material, cold worked to Parker Autoclave proprietary standards
- Operating Temperatures from -423° to 1200°F (-252° to 650°C)
- Anti-vibration connection components available, see page 15
- Special materials available when corrosion, temperature, or NACE/ISO 15156 requirements demand. (See Technical Catalog)

All Parker Autoclave Engineers fittings are marked with manufacturers name, part number, material, heat code and maximum pressure for complete traceability.

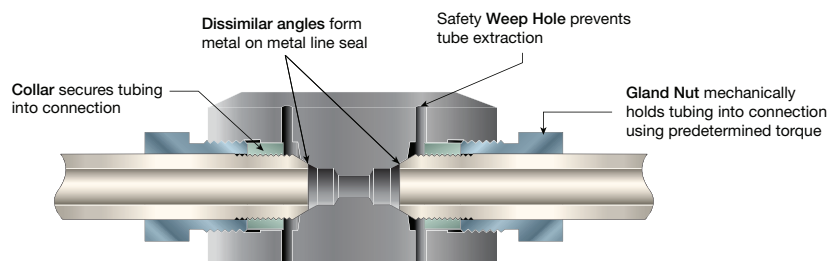

Medium Pressure “Slimline” Design

Collar in front of gland, keeping port size and fitting width to minimum



ENGINEERING YOUR SUCCESS.

Fittings

Medium Pressure Fittings - Pressures to 20,000 psi (1379 bar)



Parker Autoclave Engineers Medium Pressure fittings, nicknamed “Slimline SF”, are designed for use with SM Series valves and Parker Autoclave Engineers' Medium Pressure tubing. They incorporate coned-and-threaded connections with the orifice sized to match the high-flow 15,000 psi tubing options shown later in this brochure. For instructions on how to make this Medium Pressure Cone & Thread connection and the tools necessary to accomplish, see our “Tools and Installation” brochure.

(See “Technical Brochure” for Pressure/Temperature effect on temperatures above ambient.)

Connection Components:

All valves and fittings are supplied complete with appropriate gland and tubing collar. To order these components separately, use part numbers listed below. When using plug, collar is not required. Tubing Pressure Caps can be found in Adapter brochure.

Gland* CGLX ()

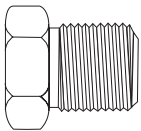

Add tube size code ()

- 1/4" - 40
- 3/8" - 60
- 9/16" - 90
- 3/4" - 120
- 1" - 160
- 1-1/2" - 240

Example: 1/4" Gland - CGLX40

All Cone and Thread ports MUST utilize weep holes for safety. When weep hole is not available, we offer a gland nut with a "Slotted Male Thread" that provides this safety feature without the need for the separate port. Use suffix **-SMT** with Gland part number when needed.

Collar CCLX ()



To ensure proper fit use Parker Autoclave Engineers tubing.

Special Materials:

Note: Special Material Fittings are supplied with CW 316 SS Glands and Collars as these parts do not touch flowing (wetted) media. To match the same material as selected for body, use either **“-SOG”** (Sour Oil or Gas - NACE) or **“-AP”** (“All Parts” (does not get hardness check typical of **-SOG** option)) suffix. Special material glands and adapter bodies are normally supplied with four flats (square) in place of standard hex. Include option suffix **“-H”** if hex is required.

For gland nut hex sizes and torque values, see “Tools and Installation” brochure. (See “Special Materials” torque chart for all materials other than CW 316 SS). *To order Antivibration Gland Fitting see page 15

Plug CPX ()

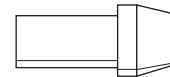

Socket Head Flush Plug version, add **“-F”** suffix

NACE/ISO 15156 Compatibility

All PAE Medium Pressure Fittings and Tubing can be made with materials suitable for NACE/ISO 15156 requirements. As per NACE and ISO-15156, it is contingent on the end user to select this material. As this compatibility limits the use of “cold worked” materials, most of the choices except for 2507 Super Duplex come with significant pressure reductions. Please consult our Technical Brochure where we identify the more popular annealed materials along with the pressure reduction. Our Sour Oil and Gas brochure has a more complete description of the available options for pressures up to 30,000 psi.

NACE Suffix adder options:

“-SOG” suffix converts all pressure containing parts from cold worked 316 SS to annealed condition material, requires hardness check, and NACE certificate is generated for each part. Pressure reductions of 60% (8,000 psi) are possible. Contact factory for other pressure/material options.

“-SOG10” suffix is the same as above but generates a part with thicker body capable of 10,000 psi MAWP (Used only with 316/316L Material)



Proudly Distributed By

TRIDENT AUSTRALIA
FLUID SYSTEMS & COMPONENTS

90° Elbow: 45° Elbows are available, replace 00 with 45 (ie; CLX6645 or CLX1645)

Catalog Number	Connection Type	Outside Diameter Tube	Pressure Rating psi (bar)*	Orifice inches (mm)	Dimensions - inches (mm)						Block Thickness
					A	B	C	D Typical	E	F	
CLX4400	SF250CX (1/4" MP)	1/4 (6.35)	20,000 (1379)	.125 (3.18)	1.12 (28.45)	1.50 (38.10)	0.38 (9.53)	0.50 (13)	0.75 (19.05)	0.75 (19.05)	0.62 (15.75)
CLX6600	SF375CX (3/8" MP)	3/8 (9.53)	20,000 (1379)	.219 (5.56)	1.38 (35.05)	2.00 (50.80)	0.44 (11.18)	0.62 (16)	1.00 (25.40)	1.00 (25.40)	0.75 (19.05)
CLX9900	SF562CX (9/16" MP)	9/16 (14.29)	20,000 (1379)	.359 (9.12)	1.75 (44.45)	2.50 (63.50)	0.53 (13.46)	0.94 (24)	1.25 (31.75)	1.25 (31.75)	1.00 (25.40)
CLX12	SF750CX (3/4" MP)	3/4 (19.05)	20,000 (1379)	.516 (13.11)	2.25 (57.15)	3.00 (76.20)	0.62 (15.75)	1.19 (30)	1.50 (38.10)	1.50 (38.10)	1.38 (34.93)
CLX16	SF1000CX (1" MP)	1 (25.40)	20,000 (1379)	.688 (17.48)	3.00 (76.20)	4.12 (104.65)	0.72 (18.29)	1.38 (35)	2.06 (52.32)	2.06 (52.32)	1.75 (44.45)
CLX24	SF1500CX (1-1/2" MP)	1-1/2 (38.10)	15,000 (1034)	.938 (23.80)	4.00 (101.60)	5.75 (146.05)	1.12 (28.45)	1.88 (48)	2.88 (73.03)	2.88 (73.03)	2.25 (57.15)

Elbow

*Maximum pressure rating is based on the lowest rating of any component. Actual working pressure may be determined by tubing pressure rating, if lower. All dimensions for reference only and subject to change.

For prompt service, Parker Autoclave Engineers stocks select products. Consult your local representative.

For mounting hole option add suffix **-PM** to catalog number. Consult factory for mounting hole dimensions. For Connection Torque requirements please see "Tools and Installation" brochure.

Conversion Adapters can be found in our "Adapter" brochure found further in main catalog or on our website.

Tee

Catalog Number	Connection Type	Outside Diameter Tube	Pressure Rating psi (bar)*	Orifice inches (mm)	Dimensions - inches (mm)						Block Thickness
					A	B	C	D Typical	E	F	
CTX4440	SF250CX (1/4" MP)	1/4 (6.35)	20,000 (1379)	.125 (3.18)	1.12 (28.45)	1.50 (38.10)	0.38 (9.53)	0.50 (13)	0.75 (19.05)	0.75 (19.05)	0.62 (15.75)
CTX6660	SF375CX (3/8" MP)	3/8 (9.53)	20,000 (1379)	.219 (5.56)	1.38 (35.05)	2.00 (50.80)	0.44 (11.18)	0.62 (16)	1.00 (25.40)	1.00 (25.40)	0.75 (19.05)
CTX9990	SF562CX (9/16" MP)	9/16 (14.29)	20,000 (1379)	.359 (9.12)	1.75 (44.45)	2.50 (63.50)	0.53 (13.46)	0.94 (24)	1.25 (31.75)	1.25 (31.75)	1.00 (25.40)
CTX12	SF750CX (3/4" MP)	3/4 (19.05)	20,000 (1379)	.516 (13.11)	2.25 (57.15)	3.00 (76.20)	0.62 (15.75)	1.19 (30)	1.50 (38.10)	1.50 (38.10)	1.38 (34.93)
CTX16	SF1000CX (1" MP)	1 (25.40)	20,000 (1379)	.688 (17.48)	3.00 (76.20)	4.12 (104.65)	0.72 (18.29)	1.38 (35)	2.06 (52.32)	2.06 (52.32)	1.75 (44.45)
CTX24	SF1500CX (1-1/2" MP)	1-1/2 (38.10)	15,000 (1034)	.938 (23.80)	4.00 (101.60)	5.75 (146.05)	1.12 (28.45)	1.88 (48)	2.88 (73.03)	2.88 (73.03)	2.25 (57.15)

Tee

*Maximum pressure rating is based on the lowest rating of any component. Actual working pressure may be determined by tubing pressure rating, if lower. All dimensions for reference only and subject to change.

For mounting hole option add suffix **-PM** to catalog number. Consult factory for mounting hole dimensions. To order Tee with different size connections of same type, change part number size codes using order shown in drawing, ie: CTX91290 would build Tee with 3/4" MP branch and 9/16" MP runs. For Connection Torque requirements please see "Tools and Installation" brochure.

Conversion Adapters can be found in our "Adapter" brochure found further in main catalog or on our website.

Cross

Catalog Number	Connection Type	Outside Diameter Tube	Pressure Rating psi (bar)*	Orifice inches (mm)	Dimensions - inches (mm)						Block Thickness
					A	B	C	D Typical	E	F	
CXX4444	SF250CX (1/4" MP)	1/4 (6.35)	20,000 (1379)	.125 (3.18)	1.50 (38.10)	1.50 (38.10)	0.38 (9.53)	0.50 (13)	0.75 (19.05)	0.75 (19.05)	0.62 (15.75)
CXX6666	SF375CX (3/8" MP)	3/8 (9.53)	20,000 (1379)	.219 (5.56)	2.00 (50.80)	2.00 (50.80)	0.44 (11.18)	0.62 (16)	1.00 (25.40)	1.00 (25.40)	0.75 (19.05)
CXX9999	SF562CX (9/16" MP)	9/16 (14.29)	20,000 (1379)	.359 (9.12)	2.50 (63.50)	2.50 (63.50)	0.53 (13.46)	0.94 (24)	1.25 (31.75)	1.25 (31.75)	1.00 (25.40)
CXX12	SF750CX (3/4" MP)	3/4 (19.05)	20,000 (1379)	.516 (13.11)	3.00 (76.20)	3.00 (76.20)	0.62 (15.75)	1.19 (30)	1.50 (38.10)	1.50 (38.10)	1.38 (34.93)
CXX16	SF1000CX (1" MP)	1 (25.40)	20,000 (1379)	.688 (17.48)	4.12 (104.65)	4.12 (104.65)	0.72 (18.29)	1.38 (35)	2.06 (52.32)	2.06 (52.32)	1.75 (44.45)
CXX24	SF1500CX (1-1/2" MP)	1-1/2 (38.10)	15,000 (1034)	.938 (23.80)	5.75 (146.05)	5.75 (146.05)	1.12 (28.45)	1.88 (48)	2.88 (73.03)	2.88 (73.03)	2.25 (57.15)

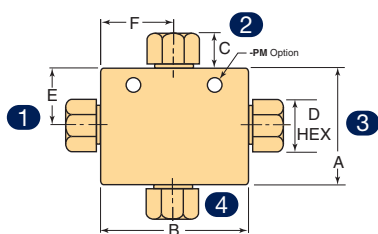

*Maximum pressure rating is based on the lowest rating of any component. Actual working pressure may be determined by tubing pressure rating, if lower. All dimensions for reference only and subject to change.

For prompt service, Parker Autoclave Engineers stocks select products. Consult your local representative.

For mounting hole option add suffix **-PM** to catalog number. Consult factory for mounting hole dimensions. To order Cross with different size connections of same type, change part number size codes using order shown in drawing, ie: CXX6969 would build a Cross with 9/16" MP alternating with 3/8" MP. For Connection Torque requirements please see "Tools and Installation" brochure.

Cross

Conversion Adapters can be found in our "Adapter" brochure found further in main catalog or on our website.

Bulkhead Coupling

Catalog Number	Connection Type	Outside Diameter Tube	Pressure Rating psi (bar)*	Orifice inches (mm)	Dimensions - inches (mm)						
					A	B	C	D Typical	E	F	G Thickness
20BFX4466	SF250CX (1/4" MP)	1/4 (6.35)	20,000 (1379)	.125 (3.18)	0.81 (20.57)	1.88 (47.75)	0.38 (9.53)	0.50 (13)	0.53 (13.46)	1.00 (25.40)	0.38 (9.53)
20BFX6666	SF375CX (3/8" MP)	3/8 (9.53)	20,000 (1379)	.219 (5.56)	0.94 (23.88)	2.00 (50.80)	0.44 (11.18)	0.62 (16)	0.62 (15.75)	1.00 (25.40)	0.38 (9.53)
20BFX9966	SF562CX (9/16" MP)	9/16 (14.29)	20,000 (1379)	.359 (9.12)	1.12 (28.45)	2.38 (60.45)	0.53 (13.46)	0.94 (24)	0.78 (19.81)	1.38 (35.05)	0.38 (9.53)
20BFX12	SF750CX (3/4" MP)	3/4 (19.05)	20,000 (1379)	.516 (13.11)	1.69 (42.93)	2.62 (66.55)	0.62 (15.75)	1.19 (30)	0.91 (23.11)	1.88 (47.75)	0.38 (9.53)
20BFX16	SF1000CX (1" MP)	1 (25.40)	20,000 (1379)	.688 (17.48)	1.94 (49.28)	3.50 (88.90)	0.72 (18.29)	1.38 (35)	1.50 (38.10)	1.88+ (47.75)	0.38 (9.53)
15BFX24	SF1500CX (1-1/2" MP)	1-1/2 (38.10)	15,000 (1034)	.938 (23.80)	2.44 (61.85)	5.00 (127.00)	1.12 (28.45)	1.88 (48)	2.00 (50.80)	2.50+ (63.50)	0.38 (9.53)

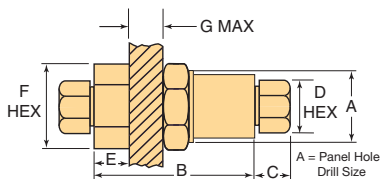

*Maximum pressure rating is based on the lowest rating of any component. Actual working pressure may be determined by tubing pressure rating, if lower.

+ distance across flats

All dimensions for reference only and subject to change. For Connection Torque requirements please see "Tools and Installation" brochure. For prompt service, Parker Autoclave Engineers stocks select products. Consult your local representative.

Bulkhead Coupling

Conversion Adapters can be found in our "Adapter" brochure found further in main catalog or on our website.



Proudly Distributed By

TRIDENT AUSTRALIA
FLUID SYSTEMS & COMPONENTS

Straight Coupling / Union Coupling

Catalog Number	Connection Type	Outside Diameter Tube	Pressure Rating psi (bar)*	Orifice inches (mm)	Dimensions - inches (mm)				Coupling Type
					A	B	C	D Typical	
20FX4466 20UFX4466	SF250CX (1/4" MP)	1/4 (6.35)	20,000 (1379)	.125 (3.18)	0.62 (15.75)	1.62 (41.15)	0.38 (9.53)	0.50 (130)	Straight Union
20FX6666 20UFX6666	SF375CX (3/8" MP)	3/8 (9.53)	20,000 (1379)	.219 (5.56)	0.75 (19.05)	1.75 (44.45)	0.44 (11.18)	0.62 (16)	Straight Union
20FX9966 20UFX9966	SF562CX (9/16" MP)	9/16 (14.29)	20,000 (1379)	.359 (9.12)	1.13 (28.70)	2.12 (53.85)	0.53 (13.46)	0.94 (24)	Straight Union
20FX12 20UFX12	SF750CX (3/4" MP)	3/4 (19.05)	20,000 (1379)	.516 (13.11)	1.38 (35.05)	2.50 (63.50)	0.62 (15.75)	1.19 (30)	Straight Union
20FX16 20UFX16	SF1000CX (1" MP)	1 (25.40)	20,000 (1379)	.688 (17.48)	1.75 (44.45)	3.50 (88.90)	0.72 (18.29)	1.38 (35)	Straight Union
15FX24 15UFX24	SF1500CX (1-1/2" MP)	1-1/2 (38.10)	15,000 (1034)	.938 (23.80)	2.25 (25.15)	5.00 (127.00)	1.12 (28.45)	1.88 (48)	Straight Union

*Maximum pressure rating is based on the lowest rating of any component. Actual working pressure may be determined by tubing pressure rating, if lower.

All dimensions for reference only and subject to change. For prompt service, Parker Autoclave Engineers stocks select products. Consult your local representative.

For Connection Torque requirements please see "Tools and Installation" brochure.

Conversion Adapters can be found in our "Adapter" brochure found further in main catalog or on our website.

Union Coupling Assembly

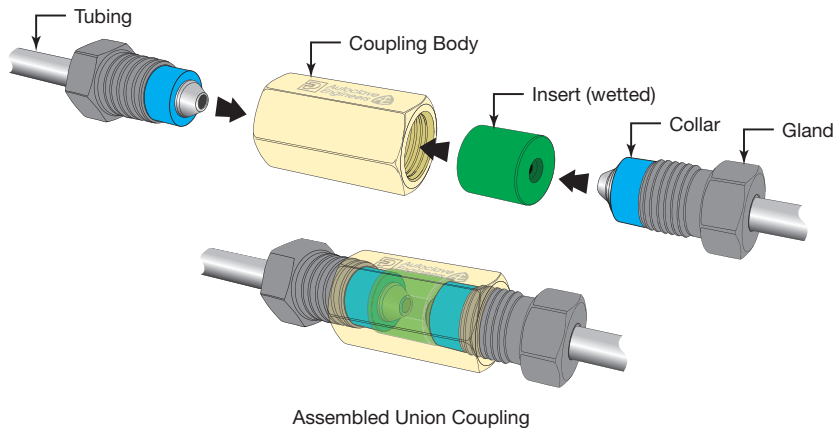

Union vs. Straight Coupling Comparison

In much the same as with a traditional Pipe Union, the PAE Union Coupling is used to easily disassemble tubing runs when valves or fittings need to be replaced after original installation. The Body and Insert are two different pieces in the same assembly. The body can slide down tubing leaving only the insert and the tubing tips engaged. Then with only minimal tube shift, the insert drops out allowing the tubing to be removed avoiding the need to disassemble multiple tubing sections from closest elbow.

Note: When Special Materials are requested, the only material that is changed is the Insert (wetted). If "All Parts" are to be requested, include suffix "-AP" or "-SOG" if for NACE/ISO 15156.

Tubing

Medium Pressure Tubing - Pressures to 20,000 psi (1379 bar)



Parker Autoclave Engineers offers a complete selection of austenetic, cold drawn stainless steel tubing designed to match the performance standards of Parker Autoclave valves and fittings. Parker Autoclave Engineers medium pressure tubing is manufactured specifically for high pressure applications requiring both strength and corrosion resistance. The tubing is furnished in random lengths between 20 feet (6 meters) and 26.5 feet (8.0 meters). The average is 24 feet (7.3 meters). Medium Pressure Tubing is available in six sizes and a variety of materials. All Parker Autoclave Engineers manufactured tubing is line marked repeatedly along the full length with our name, country of origin, Heat number, PO number, tube dimensions (Nominal OD and ID), PAE Part Number, Manufacturing Specification, and Pressure Rating (MAWP @ Room Temp).

Inspection and Testing:

Parker Autoclave Engineers' medium pressure tubing is inspected to assure freedom from seams, laps, fissures or other flaws, as well as carburization or intergranular carbide precipitation. The outside and inside diameters of the tubing are subject to special inspection and are controlled within close tolerances to assure proper fit. Sample pieces of tube for each lot are tested to confirm mechanical properties. Hydrostatic testing is also performed on a statistical basis and is conducted at the working pressure of the tube. Parker Autoclave will perform 100% hydrostatic testing at additional cost if desired.

Special Material:

In addition to the most commonly requested tubing materials CW 316 SS, 2507 Super Duplex*, and Inconel 625* (specifications on next page), we have other options outlined in our Technical brochure. These include NACE/ISO 15156 capable materials for a variety of corrosive applications.

(See "Technical Brochure" for Pressure/Temperature effect on temperatures above ambient.)

Note: * Trademark names, Please consult factory for stock availability.

Tubing Tolerance:

Parker Autoclave Engineers tubing is made to specifications that exceed all others as part of a complete "system" of products that have your safety always in mind. The outside dimension of this tubing is intentionally "undersized" to match the requirements of the threading die used to put the connection thread on the tubing. See actual dimensions and tolerancing below:

Nominal Tubing Size inches (mm)	Tolerance/Outside Diameter inches (mm)
1/4 (6.35)	.248/.243 (6.30/6.17)
3/8 (9.53)	.370/.365 (9.40/9.27)
9/16 (14.27)	.557/.552 (14.15/14.02)
3/4 (19.05)	.745/.740 (18.92/18.80)
1 (25.40)	.995/.990 (25.27/25.14)
1-1/2 (38.10)	1.495/1.490 (37.98/37.85)

Note:
Standard Tubing is manufactured in accordance with ASME B31.3 Chapter IX standards using UNS S31600/S31603, 316/316L Stainless Steel material, cold worked to Parker Autoclave proprietary standards.

Tubing outside diameter dimensions do not meet standard commercial tubing tolerances. Tubing outside dimensions are specifically chosen to meet tube threading die requirements.

Parker Autoclave Engineers components and tubing are designed as a "complete system" for safety and our fittings will not be compatible with standard "commercial" tubing.

Tubing Details: 316/316L, UNS S31600/S31603 Stainless Steel (Cold Worked)

Catalog Number	Tube Material	Fits Connection Type	Tube Size inches (mm)			Flow Area in ² (mm ²)	Working Pressure psi (bar)*			
			Outside Diameter	Inside Diameter	Wall Thickness		-423 to 100°F (-252 to 38°C)	200°F (93°C)	400°F (204°C)	600°F (316°C)
MS15-092	316SS	SF250CX	1/4 (6.35)	0.109 (2.77)	.070 (1.78)	0.009 (5.81)	20,000 (1379)	20,000 (1379)	19,000 (1310)	18,000 (1241)
MS15-093	316SS	SF375CX	3/8 (9.53)	0.203 (6.16)	.086 (2.18)	0.032 (20.66)	20,000 (1379)	20,000 (1379)	19,000 (1310)	18,000 (1241)
MS15-097	316SS	SF562CX	9/16 (14.29)	0.359 (9.12)	.101 (2.57)	.101 (65.16)	15,000 (1034)	15,000 (1034)	14,200 (979)	13,500 (931)
MS15-085	316SS			0.312 (7.92)	.125 (3.18)	.076 (49.03)	20,000 (1379)	20,000 (1379)	19,000 (1310)	18,000 (1241)
MS15-098	316SS	SF750CX	3/4 (19.06)	0.516 (13.11)	.117 (2.97)	.209 (134.84)	15,000 (1034)	15,000 (1034)	14,200 (979)	13,500 (931)
MS15-095	316SS			0.438 (11.13)	.156 (3.96)	0.151 (97.42)	20,000 (1379)	20,000 (1379)	19,000 (1310)	18,000 (1241)
MS15-099	316SS	SF1000CX	1 (25.40)	0.688 (17.48)	.156 (3.96)	.371 (239.36)	15,000 (1034)	15,000 (1034)	14,200 (979)	13,500 (931)
MS15-096	316SS			0.556 (14.27)	.219 (6.66)	0.248 (160.00)	20,000 (1379)	20,000 (1379)	19,000 (1310)	18,000 (1241)
13041	316SS	SF1500CX	1-1/2 (38.10)	0.937 (23.80)	0.281 (7.14)	0.689 (444.88)	15,000 (1034)	15,000 (1034)	14,200 (979)	13,500 (931)

Tubing Details: 2507 Super Duplex, UNS S32750 (Annealed - meets NACE/ISO 15156 & NORSOK M650, must use -S0G suffix for NACE conformance certificate)

Catalog Number	Tube Material	Fits Connection Type	Tube Size inches (mm)			Flow Area in ² (mm ²)	Working Pressure psi (bar)*			
			Outside Diameter	Inside Diameter	Wall Thickness		-50° to 100°F (-45° to 38°C)	200°F (93°C)	400°F (204°C)	600°F (316°C)
MS15-503	2507	SF250CX	1/4 (6.35)	0.109 (2.77)	.070 (1.78)	0.009 (5.81)	20,000 (1379)	17,500 (1207)	15,200 (1048)	14,400 (993)
MS15-504	2507	SF375CX	3/8 (9.53)	0.203 (6.16)	.086 (2.18)	0.032 (20.66)	20,000 (1379)	17,500 (1207)	15,200 (1048)	14,400 (993)
MS15-500	2507	SF562CX	9/16 (14.29)	0.359 (9.12)	.101 (2.57)	0.101 (65.16)	15,000 (1034)	13,200 (910)	11,400 (786.0)	10,500 (724.05)
MS15-505	2507			0.312 (7.92)	.125 (3.18)	0.076 (49.03)	20,000 (1379)	17,500 (1207)	15,200 (1048)	14,400 (993)
MS15-501	2507	SF750CX	3/4 (19.06)	0.516 (13.11)	0.017 (2.97)	0.209 (134.84)	15,000 (1034)	13,200 (910)	11,400 (786.0)	10,500 (724.05)
MS15-506	2507			0.438 (11.13)	0.156 (3.96)	0.151 (97.42)	20,000 (1379)	17,500 (1207)	15,200 (1048)	14,400 (993)
MS15-502	2507	SF1000CX	1 (25.40)	0.688 (17.48)	0.156 (3.96)	0.371 (239.36)	15,000 (1034)	13,200 (910)	11,400 (786.0)	10,500 (724.05)
MS15-507	2507			0.562 (14.27)	0.219 (5.56)	0.248 (160.00)	20,000 (1379)	17,500 (1207)	15,200 (1048)	14,400 (993)
MS15-509	2507	SF1500CX	1-1/2 (38.10)	0.937 (23.79)	.281 (7.13)	0.689 (444.88)	15,000 (1034)	13,200 (910)	11,400 (786.0)	10,500 (724.05)

Tubing Details: Inconel 625®, UNS N06625 (Annealed - meets NACE/ISO 15156, must use -S0G suffix for NACE conformance certificate)

Catalog Number	Tube Material	Fits Connection Type	Tube Size inches (mm)			Flow Area in ² (mm ²)	Working Pressure psi (bar)*			
			Outside Diameter	Inside Diameter	Wall Thickness		-423 to 100°F (-252 to 38°C)	200°F (93°C)	400°F (204°C)	600°F (316°C)
13234	IN625	SF250CX	1/4 (6.35)	0.109 (2.77)	.070 (1.78)	0.009 (5.81)	15,000 (1034)	14,100 (972)	13,600 (938)	12,800 (883)
13062	IN625	SF375CX	3/8 (9.53)	0.203 (6.16)	.086 (2.18)	0.032 (20.66)	15,000 (1034)	14,100 (972)	13,600 (938)	12,800 (883)
13233	IN625	SF562CX	9/16 (14.29)	0.312 (7.92)	.125 (3.18)	0.076 (49.03)	15,000 (1034)	14,100 (972)	13,600 (938)	12,800 (883)
13232	IN625	SF750CX	3/4 (19.06)	0.438 (11.13)	0.156 (3.96)	0.151 (97.42)	15,000 (1034)	14,100 (972)	13,600 (938)	12,800 (883)
13231	IN625	SF1000CX	1 (25.40)	0.562 (14.28)	0.219 (5.56)	0.248 (160.00)	15,000 (1034)	14,100 (972)	13,600 (938)	12,800 (883)

Note:

Caution should be exercised in proper selection of Medium Pressure Tubing based on actual operating conditions. Two series available with some sizes: 15,000 psi (1034 bar) and 20,000 psi (1379 bar).

*Maximum pressure rating is based on the lowest rating of any component. Actual working pressure may be determined by tubing pressure rating, if lower.

See Technical Section for Temperature Ratings over 600°F (315°C)

All dimensions for reference only and subject to change. For prompt service, Parker Autoclave Engineers stocks select products. Consult your local representative.



Proudly Distributed By

TRIDENT AUSTRALIA
FLUID SYSTEMS & COMPONENTS

Coned-and-Threaded Nipples

Medium Pressure - Pressures to 20,000 psi (1379 bar)



For rapid system make-up, Parker Autoclave Engineers supplies pre-cut, coned-and-threaded nipples in various sizes and lengths for Parker Autoclave Engineers Medium Pressure valves and fittings.

Special Lengths:

In addition to the standard lengths listed in the table below, nipples are available in any custom length up to total stick length. Consult factory.

Material:

Catalog numbers in table refer to Type UNS S31600/ S31603, CW 316/316L Stainless steel. Optional materials available. When changing material selection, replace -316 with replacement material suffix (-2507 for 2507 Super Duplex, -IN625 for Inconel 625). Consult Technical Brochure for additional material options.

(See "Technical Brochure" for Pressure/Temperature effect on temperatures above ambient.)

Nipple Details:

Catalog Number (316 Stainless Steel)									
Tube Size inches (mm)	Fits Connection Type								
	SF250CX	SF375CX	SF562CX	SF562CX	SF750CX	SF750CX	SF1000CX	SF1000CX	SF1500CX
Outside Diameter	1/4 (6.35)	3/8 (9.53)	9/16 (14.29)	9/16 (14.29)	3/4 (19.05)	3/4 (19.05)	1 (25.40)	1 (25.40)	1-1/2 (38.10)
Inside Diameter	.109 (2.77)	.203 (5.16)	.359 (9.12)	.312 (7.92)	.516 (13.11)	.438 (11.13)	.688 (17.48)	.562 (14.27)	.937 (23.79)
Working Pressure at 100°F (38°C) psi (bar)*	20,000 (1379)	20,000 (1379)	15,000 (1034)	20,000 (1379)	15,000 (1034)	20,000 (1379)	15,000 (1034)	20,000 (1379)	15,000 (1034)
Nipple Length inches (mm)									
2.75" (69.85)	CNX4402 -316								
3.00" (76.20)	CNX4403 -316	CNX6603 -316							
4.00" (101.60)	CNX4404 -316	CNX6604 -316	CNLX9904 -316	CNX9904 -316	CNLX1204 -316	CNX1204 -316			
6.00" (152.40)	CNX4406 -316	CNX6606 -316	CNLX9906 -316	CNX9906 -316	CNLX1206 -316	CNX1206 -316	CNLX1606 -316	CNX1606 -316	CNLX2406 -316
8.00" (203.20)	CNX4408 -316	CNX6608 -316	CNLX9908 -316	CNX9908 -316	CNLX1208 -316	CNX1208 -316	CNLX1608 -316	CNX1608 -316	CNLX2408 -316
10.00" (254.00)	CNX44010 -316	CNX66010 -316	CNLX99010 -316	CNX99010 -316	CNLX12010 -316	CNX12010 -316	CNLX16010 -316	CNX16010 -316	CNLX24010 -316
12.00" (304.80)	CNX44012 -316	CNX66012 -316	CNLX99012 -316	CNX99012 -316	CNLX12012 -316	CNX12012 -316	CNLX16012 -316	CNX16012 -316	CNLX24012 -316
14.00" (355.60)	CNX44014 -316	CNX66014 -316	CNLX99014 -316	CNX99014 -316	CNLX12014 -316	CNX12014 -316	CNLX16014 -316	CNX16014 -316	CNLX24014 -316
16.00" (406.40)	CNX44016 -316	CNX66016 -316	CNLX99016 -316	CNX99016 -316	CNLX12016 -316	CNX12016 -316	CNLX16016 -316	CNX16016 -316	CNLX24016 -316
18.00" (457.20)	CNX44018 -316	CNX66018 -316	CNLX99018 -316	CNX99018 -316	CNLX12018 -316	CNX12018 -316	CNLX16018 -316	CNX16018 -316	CNLX24018 -316
20.00" (508.00)	CNX44020 -316	CNX66020 -316	CNLX99020 -316	CNX99020 -316	CNLX12020 -316	CNX12020 -316	CNLX16020 -316	CNX16020 -316	CNLX24020 -316
22.00" (558.80)	CNX44022 -316	CNX66022 -316	CNLX99022 -316	CNX99022 -316	CNLX12022 -316	CNX12022 -316	CNLX16022 -316	CNX16022 -316	CNLX24022 -316
24.00" (609.60)	CNX44024 -316	CNX66024 -316	CNLX99024 -316	CNX99024 -316	CNLX12024 -316	CNX12024 -316	CNLX16024 -316	CNX16024 -316	CNLX24024 -316

Notes:

Caution should be exercised when selecting medium pressure nipples since two series are available: 15,000 psi (1034 bar) and 20,000 psi (1379 bar)

See medium pressure tubing section for pressures at various temperatures.

*Maximum pressure rating is based on the lowest rating of any component. Actual working pressure may be determined by tubing pressure rating, if lower.

All dimensions for reference only and subject to change.

For Connection Torque requirements please see "Tools and Installation" brochure.



Proudly Distributed By

TRIDENT AUSTRALIA
FLUID SYSTEMS & COMPONENTS

Check Valves

Medium Pressure - Pressures to 20,000 psi (1379 bar)

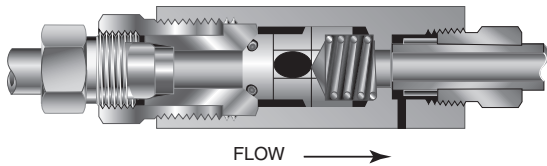

CXO Series O-Ring Check Valve

Ordering part numbers can be found on page 12

Provide unidirectional flow and tight shut-off for liquids and gases with high reliability. When differential drops below cracking pressure*, valve shuts off. **(Not for use as relief valve.)**

Cracking Pressure:

20 psi (1.38 bar) ±30%. Springs for higher cracking pressures up to 100 psi available on special order for O-ring style check valves only.

Temperature Range/O-ring Options:

Viton (FKM) O-ring (std.): 0° to 400°F (-18° to 204°C)

Buna-N O-ring (-BO suffix): -20° to 250°F (-29° to 121°C)

FFKM O-ring (-KO suffix): 0° to 500°F *(-18° to 260°C)

PTFE O-ring (-TO suffix): -100° to 400°F (-73° to 204°C)

PTFE O-ring with Low Temp Spring (-LTTO suffix): to -423°F (-252°C)

(See "Technical Brochure" for Pressure/Temperature effect on temperatures above ambient.)

Installation:

Vertical or Horizontal as required. Flow Direction arrow on valve body

CAUTION: While testing has shown O-Rings to provide satisfactory service life, both cyclic and shelf life may vary widely with differing service conditions, properties of reactants, pressure and temperature cycling and age of the O-ring. FREQUENT INSPECTIONS SHOULD BE MADE to detect any deterioration, and O-rings replaced as required.

NOTE: For optional material see Technical Brochure. Special material check valves are normally supplied with four flats in place of standard hex.

Material of Construction:

Item #	Description	Material
1	Check Valve Body	316 SS
2	Cover	316 SS
3	Poppet	316 SS
4	Gland Nut	316 SS
5	Spring	302 SS
6	O-Ring	90 Duro FKM

Typical spare parts found in Repair Kits

Basic O-ring Check Valve Repair Kits:

Check Valves are easily repaired. Add "R" to front of valve catalog number for proper repair kit (example: RCXO9900) See "Cover Torque" on page 12 for re-assembly. Include any catalog number suffix marked on original part when ordering repair kit.

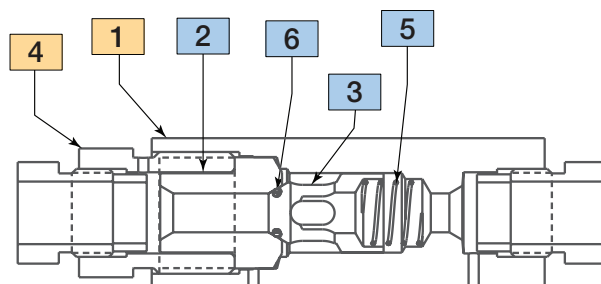



Proudly Distributed By

TRIDENT AUSTRALIA
FLUID SYSTEMS & COMPONENTS

Ball Check Valves

Medium Pressure - Pressures to 20,000 psi (1379 bar)

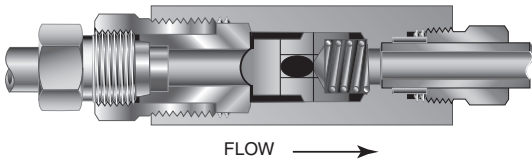

CXB Series Ball Check Valve

Ordering part numbers can be found on page 12

Prevent reverse flow **where leak-tight shut-off is not mandatory**. When differential drops below cracking pressure, valve closes. With all-metal components, valve can be used up to 800°F (425°C). See Technical Information section for connection temperature limitations. **(Not for use as relief valve.)**

Ball and poppet are an integral design to assure positive, in-line seating without “chatter”. Poppet is designed for axial flow with minimum pressure drop.

Cracking Pressure:

20 psi (1.38 bar) +/- 30% No optional cracking pressures available.

Temperature Range:

With All-Metal components, valve can be used to 800°F (425°C). Minimum standard operating temperature is -110°F (-79°C). For Low Temperature operation to -423°F (-252°C) use suffix “-LT” (Low Temp Spring)

(See “Technical Brochure” for Pressure/Temperature effect on temperatures above ambient.)

Installation:

Vertical or Horizontal as required. Flow Direction arrow on valve body

NOTE: For optional material see Technical Brochure. Special material check valves are normally supplied with four flats in place of standard hex.

Material of Construction:

Item #	Description	Material
1	Gland	316 SS
2	Gland Nut	316 SS
3	Cover	316 SS
4	Poppet	316 SS
5	Spring	302 SS
6	Check Valve Body	316 SS

Typical spare parts found in Repair Kits

Basic Ball Check Valve Repair Kits:

Check Valves are easily repaired. Add “R” to front of valve catalog number for proper repair kit (example: RCXB9900) See “Cover Torque” on page 12 for re-assembly.

Include any catalog number suffix marked on original part when ordering repair kit.

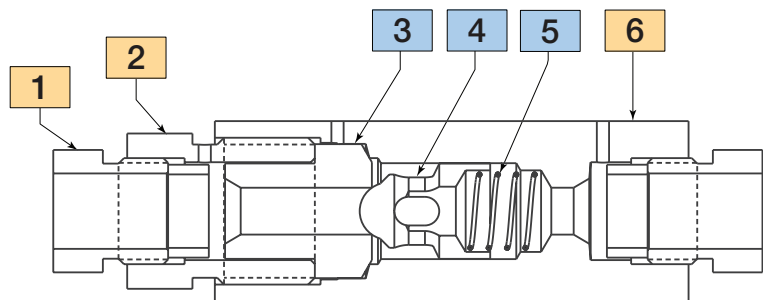



Proudly Distributed By

TRIDENT AUSTRALIA
FLUID SYSTEMS & COMPONENTS

Excess Flow Valves

Medium Pressure - Pressures to 20,000 psi (1379 bar)

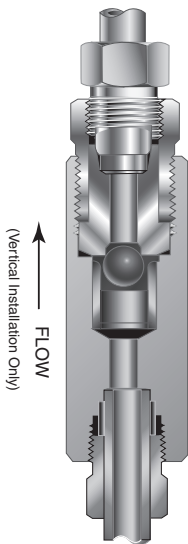

CXK Series Ball Type Excess Flow Valves (Surge Check)

Ordering part numbers can be found on page 12

Protects pressure gauges and pressure instrumentation from sudden surges in flow or venting in the event of line failure.

Vertical Installation: Since this type of check valve employs a non-spring loaded ball, valve **MUST** be installed in **VERTICAL** position with arrow on valve body pointing **UP**. (cover gland up).

Resetting Valve: Equalize the pressure across the ball. The ball will drop and reset automatically. Note: when in checked position, a small flow is permitted through the valve. See dimension chart on next page for checked flow rates).

Temperature Range:

With All-Metal components, Excess Flow Valve can be used from -423° to 800°F (-252° to 425°C).

(See "Technical Brochure" for Pressure/Temperature effect on temperatures above ambient.)

NOTE: For optional material see Needle Valve Options section. Special material check valves may be supplied with four flats in place of standard hex.

Material of Construction:

Item #	Description	Material
1	Gland Nut	316 SS
2	Cover	316 SS
3	Ball, 1/2" Diameter	302 SS
4	Sleeve	316 SS
5	Check Valve Body	316 SS

Typical spare parts found in Repair Kits

Excess Flow Valve Repair Kits

Excess Flow Valves are easily repaired. Add "R" to front of valve catalog number for proper repair kit (example: RCK9902) See "Cover Torque" on page 12 for re-assembly. Include any catalog number suffix marked on original part when ordering repair kit.

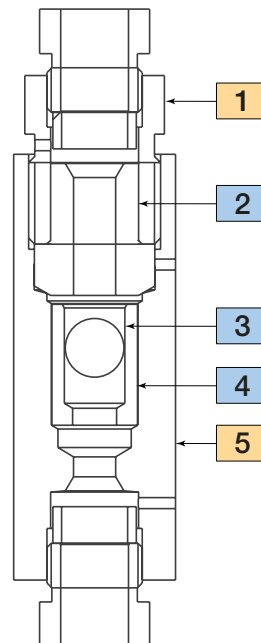



Proudly Distributed By

TRIDENT AUSTRALIA
FLUID SYSTEMS & COMPONENTS

O-Ring Check Valves

Catalog Number	Fits Connection Type	Pressure Rating psi (bar)*	Orifice inches (mm)	Rated Cv	Cover Torque ft.lb (Nm)	Dimensions - inches (mm)				
						A	B	C	D Typical	Hex
CXO4400	SF250CX (1/4" MP)	20,000 (1379)	.125 (3.18)	.28	40 (54)	2.94 (74.68)	2.50 (63.50)	0.38 (9.53)	0.50 (13)	0.81 (20.57)
CXO6600	SF375CX (3/8" MP)	20,000 (1379)	.218 (5.54)	.84	65 (88)	3.12 (79.25)	2.62 (66.55)	0.47 (11.94)	0.62 (16)	1.00 (25.40)
CXO9900	SF562CX (9/16" MP)	20,000 (1379)	.359 (9.12)	2.30	140 (190)	4.18 (106.17)	3.50 (88.90)	0.53 (13.46)	0.94 (24)	1.38 (35.05)
CXO12	SF750CX (3/4" MP)	20,000 (1379)	.516 (13.11)	4.70	230 (312)	5.50 (139.70)	4.75 (120.65)	0.62 (15.75)	1.19 (30)	1.75 (44.45)
CXO16	SF1000CX (1" MP)	20,000 (1379)	.688 (17.48)	7.40	700 (950)	6.63 (168.40)	5.75 (146.05)	0.72 (18.29)	1.38 (35)	1.88++ (47.75)
CXO24	SF1500CX (1-1/2" MP)	15,000 (1034)	.938 (23.80)	14.00	1500 (2033)	9.01 (228.85)	7.25 (184.15)	1.12 (28.45)	1.88 (48)	3.00++ (76.20)

Ball Check Valves

CXB4400	SF250CX (1/4" MP)	20,000 (1379)	.125 (3.18)	.28	40 (54)	2.94 (74.68)	2.50 (63.50)	0.38 (9.53)	0.50 (13)	0.81 (20.57)
CXB6600	SF375CX (3/8" MP)	20,000 (1379)	.218 (5.54)	.84	65 (88)	3.12 (79.25)	2.62 (66.55)	0.47 (11.94)	0.62 (16)	1.00 (25.40)
CXB9900	SF562CX (9/16" MP)	20,000 (1379)	.359 (9.12)	2.30	140 (190)	4.18 (106.17)	3.50 (88.90)	0.53 (13.46)	0.94 (24)	1.38 (35.05)
CXB12	SF750CX (3/4" MP)	20,000 (1379)	.516 (13.11)	4.70	230 (312)	5.50 (139.70)	4.75 (120.65)	0.62 (15.75)	1.19 (30)	1.75 (44.45)
CXB16	SF1000CX (1" MP)	20,000 (1379)	.688 (17.48)	7.40	700 (950)	6.63 (168.40)	5.75 (146.05)	0.72 (18.29)	1.38 (35)	1.88++ (47.75)
CXB24	SF1500CX (1-1/2" MP)	15,000 (1034)	.938 (23.80)	14.00	1500 (2033)	9.01 (228.85)	7.25 (184.15)	1.12 (28.45)	1.88 (48)	3.00++ (76.20)

Ball Type Excess Flow Valves

CXK4402	SF250CX (1/4" MP)	20,000 (1379)	.125 (3.18)	.037+	40 (54)	2.94 (74.68)	2.50 (63.50)	0.38 (9.53)	0.50 (13)	0.81 (20.57)
CXK6602	SF375CX (3/8" MP)	20,000 (1379)	.218 (5.54)	.066+	65 (88)	3.12 (79.25)	2.62 (66.55)	0.47 (11.94)	0.62 (16)	1.00 (25.40)
CXK9902	SF562CX (9/16" MP)	20,000 (1379)	.359 (9.12)	.212+	140 (190)	4.18 (106.17)	3.50 (88.90)	0.53 (13.46)	0.94 (24)	1.38 (35.05)
CXK1202	SF750CX (3/4" MP)	20,000 (1379)	.516 (13.11)	.368+	230 (312)	5.12 (130.05)	4.38 (111.25)	0.62 (15.75)	1.19 (30)	1.75 (44.45)
CXK1602	SF1000CX (1" MP)	20,000 (1379)	.688 (17.48)	.864+	700 (950)	6.50 (165.10)	5.62 (142.75)	0.72 (18.29)	1.38 (35)	1.88++ (47.75)

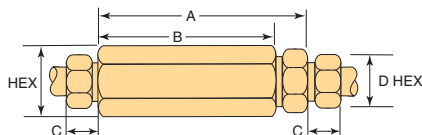

Check and Excess Flow Valve Dimensions

NOTE: For optional material see Technical Brochure. Special material check valves are normally supplied with four flats in place of standard hex.

Note:

+ Check Flow - water, GPM
++ Distance across flats

* Maximum pressure rating is based on the lowest rating of any component. Actual working pressure may be determined by tubing pressure rating, if lower. All dimensions for reference only and subject to change. For prompt service, Parker Autoclave stocks select products. Consult your local representative. To change material from standard 316SS, add material suffix (see Technical brochure for pressure reduction) after part number above. Please note: Only "wetted" material is changed, not collars and gland nuts. If needed, use additional suffix -AP (All Parts).

Line Filters

Medium Pressure - Pressures to 20,000 psi (1379 bar)

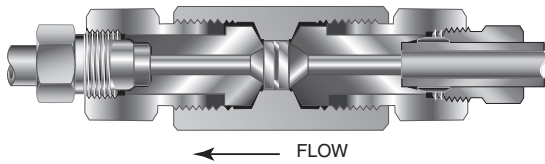

CLFX Series Dual Disc Line Filters

NOTE: Ordering Part Number can be found on Page 14

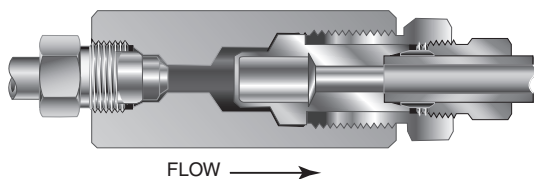

CFX Series Cup Type Line Filters

NOTE: Ordering Part Number can be found on Page 14

Dual-Disc Line Filters are utilized in numerous industrial, chemical processing, aerospace, nuclear and other applications. With the dual-disc design, large contaminant particles are trapped by the upstream filter element before they can reach and clog the smaller micron-size downstream element. Filter elements can be easily replaced.

Materials: Body, Cover, Gland Nut: CW 316 Stainless Steel.

Filter Element: 316L Stainless Steel, Sintered Disc Type. Downstream/upstream micron size 35/65 is standard. 5/10 or 10/35 also available when specified. Other element combinations available on special order.

High Flow Cup-Type Line Filters are recommended in medium pressure systems requiring both high flow rates and maximum filter surface area. Widely used in the industrial and chemical processing fields, the cup design offers as much as six times the effective filter area as compared to disc-type units. In addition, the filter elements can be quickly and easily replaced.

Materials: Body, Cover, Gland Nut: CW 316 Stainless Steel.

Filter Element: 316L Stainless Steel, Sintered Cup Type. Standard elements available in choice of 5, 35 or 65 micron sizes. **Note:** Filter ratings are nominal.

Temperature Range: Both Models:
 Oxidizing Fluids: 750°F (400°C) maximum
 Non-Oxidizing Fluids: 900°F (480°C) -423°F (-252°C) minimum
 (See "Technical Brochure" for Pressure/Temperature effect on temperatures above ambient.)

Spare Parts: Filter Elements are only replaceable part with either filter type. See chart on page 14 for Filter Element part numbers.

NOTE 1: All filters furnished complete with connection components unless otherwise specified. All dimensions for reference only and subject to change. Limited special material options are available, consult factory for assistance.

NOTE 2: Parker Autoclave Engineers disc and cup type filters are designed to filter small amounts of process particles. It is recommended that all fluids are thoroughly cleaned prior to entering the higher pressure system.

NOTE 3: Special material filters may be supplied with four flats in place of standard hex.

NOTE 4: Pressure differential not to exceed 1,000 psi (69 bar) in a flowing condition. This is indication to replace filter.

NOTE 5: Larger micron size filter element is installed on the upstream (inlet) side.



Proudly Distributed By

TRIDENT AUSTRALIA
FLUID SYSTEMS & COMPONENTS

Dual Disc Line Filters - Medium Pressure, 20,000 psi

Catalog Number	Connection Size & Type	Orifice inches (mm)	Micron Size** "um"	Replacement Filter P/N	Cover Gland Torque	Effective Filter Area in ² (mm ²)	Dimensions - inches (mm)				
							A	B	C	D Typical	Hex
CLFX9900	SF562CX (9/16" MP)	.250 (6.35)	35/65	65um = P-0764 35um = P-0794	140 (190)	.25 (161.29)	4.94 (126.48)	2.68 (68.07)	0.53 (13.46)	0.94 (24)	1.38 (35)
CLFX9900-5/10			5/10	10um = P-1784 5um = P-1783							
CLFX9900-10/35			10/35	35um = P-0794 10um = P-1784							

Cup Type Line Filters - Medium Pressure, 20,000 psi

CXF4-5	SF250CX (1/4" MP)	.125 (3.18)	5	201A-2916	40 (55)	.81 (522.57)	2.94 (74.68)	2.50 (63.60)	0.38 (9.63)	0.50 (13)	0.81 (21)
CXF4-35			35	203A-2916							
CXF4-65			65	204A-2916							
CXF6-5	SF375CX (3/8" MP)	.218 (6.64)	5	201A-2916	65 (90)	.81 (522.57)	3.12 (79.26)	2.60 (66.55)	0.47 (11.99)	0.62 (16)	1.00 (25)
CXF6-35			35	203A-2916							
CXF6-65			65	204A-2916							
CXF9-5	SF562CX (9/16" MP)	.359 (9.12)	5	205A-2916	140 (190)	1.53 (987.09)	4.18 (106.17)	3.50 (88.90)	0.53 (13.46)	0.94 (24)	1.38 (35)
CXF9-35			35	207A-2916							
CXF9-65			65	208A-2916							
CXF12-5	SF750CX (3/4" MP)	.516 (13.10)	5	248A-2916	600 (810)	2.65 (1709.67)	5.50 (139.70)	4.75 (120.66)	0.62 (15.75)	1.18 (38)	2.12 (53)
CXF12-65			65	250A-2916							
CXF16-5	SF1000CX (1" MP)	.688 (17.48)	5	248A-2916	600 (810)	5.00 (3225.80)	6.62 (168.15)	5.75 (146.05)	0.72 (18.29)	1.38 (35)	2.12 (53)
CXF16-65			65	250A-2916							

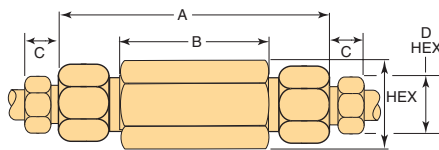

Dual Disc Line Filter Dimensions

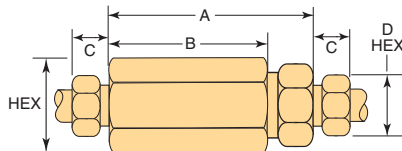

Cup Type Line Filter Dimensions

* Maximum pressure rating is based on the lowest rating of any component including tubing used.

** Other micron sizes available on special order. Consult Factory.

For optional materials, see Technical Brochure

All dimensions for reference only and subject to change.

For prompt service, Parker Autoclave Engineers stocks select products.

Consult your local representative.

To change material from standard 316SS, add material suffix (see Technical brochure for pressure reduction) after part number above. Please note: Only "wetted" material is changed, not collars and gland nuts. If needed, use additional suffix **-AP** (All Parts).

For Connection Torque requirements please see "Tools and Installation" brochure.

Anti-Vibration Collet Gland Assembly

Medium Pressure - Pressures to 20,000 psi (1379 bar)

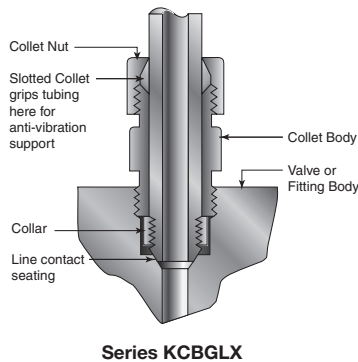

Series KCBGLX (sizes to 1-1/2" (38.10 mm))

For extreme conditions of vibration and/or shock in tubing systems, such as an unsupported line near a compressor, coned-and-threaded connections are offered with the Parker Autoclave anti-vibration collet gland assembly. Originally patented in 1968 the collet gland assembly is designed to be completely interchangeable with standard Parker Autoclave Engineers Medium Pressure gland connections, the collet gland assembly provides equally effective pressure handling capability.

In standard connection systems, the bending stresses on the threaded area of the tubing imposed by excessive vibration or movement may cause premature fatigue failure of the tubing at the back of the thread. By moving the stress concentration back to the unthreaded part of the tubing and providing a wedge-type gripping action, the Parker Autoclave Engineers anti-vibration collet gland assembly strengthens the entire structure while preventing rotation. With stress concentration reduced and overall stress level maintained well below the endurance limit of the material, the result is virtually unlimited vibrational fatigue life.

A less complex and more economical design than other vibration-resistant connections, the collet gland assembly utilizes the same coned-and-threaded features of Parker Autoclave Engineers medium pressure connections. Series KCBGLX extends the gland nut to provide room for the tapered slotted collet. The design provides a slight difference in angles between the collet and the corresponding taper of the gland nut. As the nut is tightened, it acts to wedge the tapered end of the collet into a gripping engagement with the tubing.

Material:

316 SS with bonded dry film molybdenum disulfide to help prevent galling. Additional thread lubricant not needed.

Note:

- 1) To order valve and fitting components with anti-vibration assemblies add **-K** to catalog numbers.
- 2) Special material assemblies are normally supplied with four flats in place of standard hex.
- 3) See Tools and Installation Catalog for Installation Instructions including Torque Specifications.



Proudly Distributed By

TRIDENT AUSTRALIA
FLUID SYSTEMS & COMPONENTS

Anti-Vibration Collet Gland Assembly

Medium Pressure - Pressures to 20,000 psi (1379 bar)

Anti-Vibration Collet Gland Assembly Details:

Complete Assembly Catalog Number	Part	Nominal Tubing Size Inches (mm)	Dimensions: Inches (mm)			
			A	B	Collet Nut Hex	Body Hex
KCBGLX40-316MC	Complete Assembly	1/4"	0.94 (23.88)	1.19 (30.23)	5/8"	1/2"
KCBGLX60-316MC	Complete Assembly	3/8"	1.19 (30.23)	1.50 (38.10)	13/16"	5/8"
KCBGLX90-316MC	Complete Assembly	9/16"	1.41 (35.81)	1.78 (45.21)	15/16"	15/16"
KCBGLX120-316MC	Complete Assembly	3/4"	1.59 (40.37)	2.00 (50.80)	1-3/8"	1-3/16"
KCBGLX160-316MC	Complete Assembly	1"	1.69 (42.93)	2.38 (60.45)	1-1/2"	1-3/8"
KCBGLX240-316MC	Complete Assembly	1-1/2"	2.75 (69.85)	3.63 (92.20)	2-1/4"	1-7/8"

All dimensions for reference only and subject to change.
For prompt service, Parker Autoclave Engineers stocks select products. Consult your local representative.

Antivibration Gland assemblies made with any optional material will be coated with dry film molybdenum disulfide to help prevent galling. See Tools and Installation brochure for reduced torque ratings.

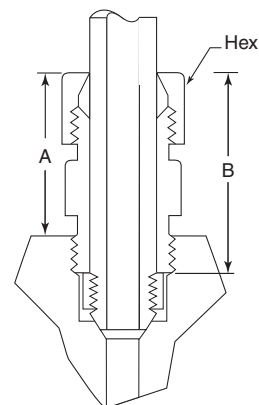

Series KCBGLX
20,000 psi (1379 bar)
(when used in PAE fittings or valves)

Standard Parker Autoclave Engineers collar not included in Antivibration Gland Assembly if ordered separately.

Always use back-up wrench on collet body when tightening collet nut to prevent over-torquing connection.



Assembly Instructions

Medium Pressure Fittings - Pressures to 20,000 psi (1379 bar)

Medium Pressure Connection: Step by Step Assembly Instructions

Step 1	Step 2	Step 3																				
<p>Insert Coned and Threaded Nipple through Gland (Typical Elbow Fitting Assembly consisting of Fitting Body, Collar, Gland, and Coned and Threaded Nipple or Tube End.)</p>	<p>Thread Collar turning (Reverse Threaded to prevent rotation during torque process) onto Coned and Threaded Nipple end.</p>	<p>For proper Collar placement, thread Collar onto Nipple leaving 1-1/2 to 2 full threads exposed on Fitting side of Collar. Lubricate Gland Threads and Collar Contact surface with anti-seize compound and tube tip with process compatible lubricant (do not use metal-flake type on tube or adapter tip)</p>																				
Step 4	Step 5	Medium Pressure Gland Torque																				
		<p>For 316/316L SS, 2507 Super Duplex Tubing & Adapters</p> <table border="1"> <thead> <tr> <th>Fitting Size</th> <th>Required Torque ft-lb (N.m)</th> </tr> </thead> <tbody> <tr> <td>1/4" MP</td> <td>20 (27)</td> </tr> <tr> <td>3/8" MP</td> <td>30 (41)</td> </tr> <tr> <td>9/16" MP-15Ksi</td> <td>55 (75)</td> </tr> <tr> <td>9/16" MP-20Ksi</td> <td>55 (75)</td> </tr> <tr> <td>3/4" MP-15Ksi</td> <td>75 (102)</td> </tr> <tr> <td>3/4" MP-20Ksi</td> <td>90 (122)</td> </tr> <tr> <td>1" MP-15Ksi</td> <td>135 (187)</td> </tr> <tr> <td>1" MP-20Ksi</td> <td>135 (187)</td> </tr> <tr> <td>1-1/2" MP</td> <td>200 (272)</td> </tr> </tbody> </table> <p>Torque for optional materials and pressures lower than maximum (above)</p>	Fitting Size	Required Torque ft-lb (N.m)	1/4" MP	20 (27)	3/8" MP	30 (41)	9/16" MP-15Ksi	55 (75)	9/16" MP-20Ksi	55 (75)	3/4" MP-15Ksi	75 (102)	3/4" MP-20Ksi	90 (122)	1" MP-15Ksi	135 (187)	1" MP-20Ksi	135 (187)	1-1/2" MP	200 (272)
Fitting Size	Required Torque ft-lb (N.m)																					
1/4" MP	20 (27)																					
3/8" MP	30 (41)																					
9/16" MP-15Ksi	55 (75)																					
9/16" MP-20Ksi	55 (75)																					
3/4" MP-15Ksi	75 (102)																					
3/4" MP-20Ksi	90 (122)																					
1" MP-15Ksi	135 (187)																					
1" MP-20Ksi	135 (187)																					
1-1/2" MP	200 (272)																					
<p>Insert Tube/Gland assembly into Fitting body, turning clockwise approximately 4-5 threads (if unable to turn full distance by hand, look for misalignment issues with tubing and correct for proper seal).</p>	<p>Use Torque Wrench to properly set (see chart in next frame) Cone & Thread Connections. (Available with wrench adapters in Tools and Installation brochure)</p>																					



TRIDENT AUSTRALIA
FLUID SYSTEMS & COMPONENTS

Proudly Distributed By

NOTES:

Multiple horizontal lines for handwritten notes.



High Pressure
Valves • Fittings • Tubing
to 150,000 psi.



Reactors • Vessels
Instrumentation



Air Driven, High Flow,
High Pressure Liquid Pumps

THIS IS PARKER

Parker's Motion & Control Technologies

At Parker, we're guided by a relentless drive to help our customers become more productive and achieve higher levels of profitability by engineering the best systems for their requirements. It means looking at customer applications from many angles to find new ways to create value. Whatever the motion and control technology need, Parker has the experience, breadth of product and global reach to consistently deliver. No company knows more about motion and control technology than Parker. For further information call 1-800-C-Parker.

MARKET	KEY MARKETS	KEY PRODUCTS		
 AEROSPACE	Aircraft Engines Commercial Commerical Transports Military Aircraft Regional Transports	Business and General Aviation Land-Based Weapons Systems Missiles and Launch Vehicles Unmanned Aerial Vehicles	Flight Control Systems & Components Fluid Conveyance Systems Fluid Metering Delivery & Atomization Devices Fuel Systems & Components	Hydraulic Systems & Components Inert Nitrogen Generating Systems Pneumatic Systems & Components Wheels & Brakes
 CLIMATE CONTROL	Agriculture Food, Beverage and Dairy Precision Cooling Transportation	Air Conditioning Life Sciences & Medical Processing	Co2 Controls Electronic Controllers Filter Driers Hand Shut-Off Valves Hose & Fittings	Pressure Regulating Valves Refrigerant Distributors Safety Relief Valves Solenoid Valves Thermostatic Expansion Valves
 ELECTRO-MECHANICAL	Aerospace Life Science & Medical Packaging Machinery Plastics Machinery & Converting Semiconductor & Electronics Factory Automation	Machine Tools Paper Machinery Primary Metals Textile Wire & Cable	AC/DC Drives & Systems Electric Actuators, Gantry Robots & Slides Electrohydrostatic Actuation Systems Electromechanical Actuation Systems Human Machine Interface	Linear Motors Stepper Motors, Servo Motors Drives & Controls Structural Extrusions
 FILTRATION	Food & Beverage Life Sciences Mobile Equipment Power Generation Transportation	Industrial Machinery Marine Oil & Gas Process	Analytical Gas Generators Compressed Air & Gas Filters Condition Monitoring Engine Air, Fuel & Oil Filtration & Systems	Hydraulic, Lubrication & Coolant Filters Process, Chemical, Water Microfiltration Filters Nitrogen, Hydrogen & Zero Air Generators
 FLUID and GAS HANDLING	Aerospace Agriculture Bulk Chemical Handling Construction Machinery Food & Beverage Fuel & Gas Delivery	Industrial Machinery Mobile Oil & Gas Transportation Welding	Brass Fittings & Valves Diagnostic Equipment Fluid Conveyance Systems Industrial Hose	PTFE & PFA Hose, Tubing & Plastic Fittings Rubber & Thermoplastic Hose & Couplings Tube Fittings & Adapters Quick Disconnects
 HYDRAULICS	Aerospace Aerial lift Agriculture Construction Machinery Forestry	Industrial Machinery Mining Oil & Gas Power Generation & Energy Truck Hydraulics	Diagnostic Equipment Hydraulic Cylinders & Accumulators Hydraulic Motors & Pumps Hydraulic Systems Hydraulic Valves & Controls	Power Take-Offs Rubber & Thermoplastic Hose & Couplings Tube Fittings & Adapters Quick Disconnects
 PNEUMATICS	Aerospace Conveyor & Material Handling Factory Automation Life Science & Medical	Machine Tools Packaging Machinery Transportation & Automotive	Air Preparation Brass Fittings & Valves Manifolds Pneumatic Accessories Pneumatic Actuators & Grippers Pneumatic Valves & Controls	Quick Disconnects Rotary Actuators Rubber & Thermoplastic Hose & Couplings Structural Extrusions Thermoplastic Tubing & Fittings Vacuum Generators, Cups & Sensors
 PROCESS CONTROL	Chemical & Refining Food, Beverage & Dairy Medical & Dental	Microelectronics Oil & Gas Power Generation	Analytical Sample Conditioning Products & Systems Fluoropolymer Chemical Delivery Fittings, Valves & Pumps High Purity Gas Delivery Fittings, & Valves & Regulators	Instrumentation Fittings, Valves Regulators Medium Pressure Fittings & Valves Process Control Manifolds
 SEALING and SHIELDING	Aerospace Chemical Processing Consumer Energy, Oil & Gas Fluid Power General Industrial	Information Technology Life Sciences Military Semiconductor Transportation	Dynamic Seals Elastomeric O-Rings Emi Shielding Extruded & Precision-Cut, Fabricated Elastomeric Seals	Homogeneous & Inserted Elastomeric Shapes High Temperature Metal Seals Metal & Plastic Retained Composite Seals Thermal Management

Parker Worldwide

North America

USA – Corporate, Cleveland, OH
Tel: +1 256 896 3000

USA – IPD, Huntsville, AL
Tel: +1 256 881 2040
ipdctc@parker.com

USA – IPD, (Autoclave), Erie, PA
Tel: +1 814 860 5700
ipdaecc@parker.com

CA – Canada, Grimsby, Ontario
Tel: +1 905-945-2274
ipd_canada@parker.com

South America

AR – Argentina, Buenos Aires
Tel: +54 3327 44 4129
falecom@parker.com

BR – Brazil, Diadema, SP
Diadema, SP
Tel: +55 11 4360 6700
falecom@parker.com

CL – Chile, Santiago
Tel: +56 (0) 2 2303 9640
falecom@parker.com

MX – Mexico, Toluca
Tel: +52 722 275 4200
contacto@parker.com

Asia Pacific

AU – Australia, Dandenong
Tel: +61 (0)2 9842 5150
customer.service.au@parker.com

CN – China, Shanghai
Tel: +86 21 2899 5000
INGtechnical.china@parker.com

HK – Hong Kong
Tel: +852 2428 8008

IN – India, Mumbai
Tel: +91 22 6513 7081-85

ID – Indonesia, Tangerang
Tel: +62 2977 7900
parker.id@parker.com

JP – Japan, Tokyo
Tel: +(81) 3 6365 4020
infopjh@parker.com

KR – South Korea, Seoul
Tel: +82 2 559 0400
parkerkr@parker.com

MY – Malaysia, Selangor
Tel: +603 784 90 800
parkermy@parker.com

SG – Singapore,
Tel: +65 6887 6300
parker.sg@parker.com

TH – Thailand, Bangkok
Tel: +66 2 186 7000
phthailand@parker.com

TW – Taiwan, Taipei
Tel: +886 2 2298 8987
enquiry.taiwan@parker.com

VN – Vietnam, Hochi Minh City
Tel: +848 382 508 56
parker_viet@parker.com

Europe, Middle East, Africa

AE – UAE, Dubai
Tel: +971 4 812 7100
parker.me@parker.com

AT – Austria, Wiener Neustadt
Tel: +43 (0)2622 23501-0
parker.austria@parker.com

AT – Eastern Europe, Wiener Neustadt
Tel: +43 (0)2622 23501 900
parker.easteurope@parker.com

AZ – Azerbaijan, Baku
Tel: +994 50 2233 458
parker.azerbaijan@parker.com

BE/LU – Belgium, Nivelles
Tel: +32 (0)67 280 900
parker.belgium@parker.com

BG – Bulgaria, Sofia
Tel: +359 2 980 1344
parker.bulgaria@parker.com

BY – Belarus, Minsk
Tel: +48 (0)22 573 24 00
parker.belarus@parker.com

CH – Switzerland, Etoy
Tel: +41 (0) 21 821 87 00
parker.switzerland@parker.com

CZ – Czech Republic, Klecany
Tel: +420 284 083 111
parker.czechrepublic@parker.com

DE – Germany, Kaarst
Tel: +49 (0)2131 4016 0
parker.germany@parker.com

DK – Denmark, Ballerup
Tel: +45 43 56 04 00
parker.denmark@parker.com

ES – Spain, Madrid
Tel: +34 902 33 00 01
parker.spain@parker.com

FI – Finland, Vantaa
Tel: +358 (0)20 753 2500
parker.finland@parker.com

FR – France, Contamine s/Arve
Tel: +33 (0)4 50 25 80 25
parker.france@parker.com

GR – Greece, Athens
Tel: +30 210 933 6450
parker.greece@parker.com

HU – Hungary, Budapest
Tel: +36 223 885 470
parker.hungary@parker.com

IE – Ireland, Dublin
Tel: +353 (0)1 466 6370
parker.ireland@parker.com

IT – Italy, Corsico (MI)
Tel: +39 02 45 19 21
parker.italy@parker.com

KZ – Kazakhstan, Almaty
Tel: +7 7273 561 000
parker.easteurope@parker.com

NL – The Netherlands, Oldenzaal
Tel: +31 (0)541 585 000
parker.nl@parker.com

NO – Norway, Stavanger
Tel: +47 66 75 34 00
parker.norway@parker.com

PL – Poland, Warsaw
Tel: +48 (0)22 573 24 00
parker.poland@parker.com

PT – Portugal, Leca da Palmeira
Tel: +351 22 999 7360
parker.portugal@parker.com

RO – Romania, Bucharest
Tel: +40 21 252 1382
parker.romania@parker.com

RU – Russia, Moscow
Tel: +7 495 645-2156
parker.russia@parker.com

SE – Sweden, Spånga
Tel: +46 (0)8 59 79 50 00
parker.sweden@parker.com

SK – Slovakia, Banská Bystrica
Tel: +421 484 162 252
parker.slovakia@parker.com

SL – Slovenia, Novo Mesto
Tel: +386 7 337 6650
parker.slovenia@parker.com

TR – Turkey, Istanbul
Tel: +90 216 4997081
parker.turkey@parker.com

UA – Ukraine, Kiev
Tel: +48 (0)22 573 24 00
parker.ukraine@parker.com

UK – United Kingdom, Warwick
Tel: +44 (0)1926 317 878
parker.uk@parker.com

ZA – South Africa, Kempton Park
Tel: +27 (0)11 961 0700
parker.southafrica@parker.com

! CAUTION !

Do not mix or interchange component parts or tubing with those of other manufacturers. Doing so is unsafe and will void warranty.

Parker Autoclave Engineers Valves, Fittings, and Tools are not designed to interface with common commercial instrument tubing and are designed to only connect with tubing manufactured to Parker Autoclave Engineers AES specifications. Failure to do so is unsafe and will void warranty.

WARNING

FAILURE, IMPROPER SELECTION OR IMPROPER USE OF THE PRODUCTS AND/OR SYSTEMS DESCRIBED HEREIN OR RELATED ITEMS CAN CAUSE DEATH, PERSONAL INJURY AND PROPERTY DAMAGE.

This document and other information from Parker Hannifin Corporation, its subsidiaries and authorized distributors provide product and/or system options for further investigation by users having technical expertise. It is important that you analyze all aspects of your application and review the information concerning the product or system in the current product catalog. Due to the variety of operating conditions and applications for these products or systems, the user, through its own analysis and testing, is solely responsible for making the final selection of the products and systems and assuring that all performance, safety and warning requirements of the application are met. The products described herein, including without limitation, product features, specifications, designs, availability and pricing, are subject to change by Parker Hannifin Corporation and its subsidiaries at any time without notice.

Offer of Sale

The items described in this document are available for sale by Parker Hannifin Corporation, its subsidiaries or its authorized distributors. Any sale contract entered by Parker will be governed by the provisions stated in Parker's standard terms and conditions of sale (copy available upon request).



Instrumentation Products Division
Autoclave Engineers Operation
8325 Hessinger Drive
Erie, PA 16509-4679
Tel: 814 860 5700
Fax: 814 860 5811
www.autoclave.com
www.parker.com/ipd

ISO-9001 Certified

Instrumentation Products Division
Division Headquarters
1005 A Cleaner Way
Huntsville, AL 35805 USA
Tel: 256 881 2040
Fax: 256 881 5072

Parker Hannifin Manufacturing Ltd.
Instrumentation Products Division,
Europe
Riverside Road
Pottington Business Park
Barnstaple, UK, EX31 1NP, UK
Tel: 44 1271 313131
Fax: 44 1271 373636