

# Fittings and Tubing

## High Pressure Cone & Thread

Pressures to 60,000 psi (4140 bar)  
Includes Check Valves, Filters & Couplings



### Principle of Operation:

Parker Autoclave Engineers High Pressure connection is a refinement of the original cone & thread joint which has been the standard connection in high pressure technology since its development by an agency of the US Government over 90 years ago. This design set precedence of quality and reliability found in all Parker Autoclave Engineers products to this day.

The pressure handling capabilities of this connection design have been applied successfully to control pressures in excess of 150,000 psi. All-metal sealing and working temperatures from -423° to 1200°F (-252° to 650°C), along with many different material options make this connection one of the most versatile ever. Fittings and tubing found in this section are designed using ASME B31.3 Chapter IX standards to be compatible with all of our High Pressure Valve and Fitting configurations.

### High Pressure Fittings and Tubing Features:

- Utilize "F" Style High Pressure Coned-and-Threaded connections (see Tools & Installation for port dimensions)
- Available sizes are 1/4, 3/8, 9/16, and 1 inch nominal outside diameter tubing
- Standard Fitting Material is UNS S31600 with Tubing manufactured using UNS S31600/S31603, 316/316L stainless steel material, cold worked to Parker Autoclave proprietary standards. UNS S30400/S30403, 304 SS tubing is available
- Operating Temperatures from -423°F to 1200°F (-252° to 650°C)
- Anti-vibration connection components available, see pages 15 & 16
- High pressure, High cycle Autofrettaged tubing available along with many material options.
- Fitting and Tubing options for 100,000 and 150,000 psi applications available, see Ultra High Fitting brochure

All Parker Autoclave Engineers fittings are marked with manufacturers name, part number, material, heat code and maximum pressure for complete traceability.

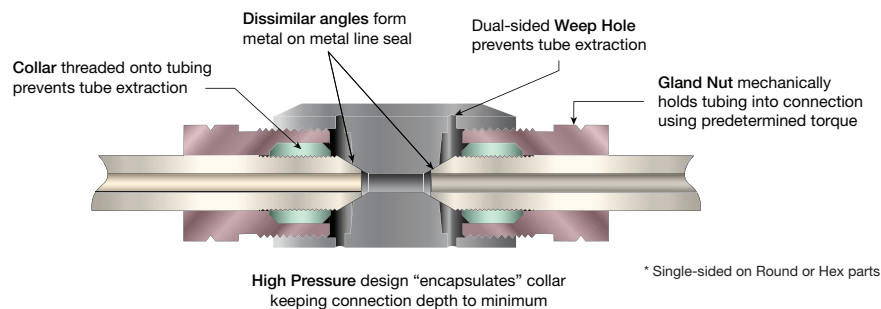

ENGINEERING YOUR SUCCESS.

# Fittings

High Pressure Fittings - Pressures to 60,000 psi (4140 bar)









Parker Autoclave Engineers High Pressure Cone & Thread Fittings, Couplings, Filters and Valves utilize the F Style Cone & Thread Connection Detail (see Tools & Installation brochure for dimensions). These fittings are compatible with Series 30SC, 43SC, 30VM, 40VM, and 60VM valves and Parker Autoclave Engineers high pressure tubing.

For instructions on how to make this High Pressure Cone & Thread connection see the step by step instructions on page 7.

## High Pressure Connection Components:

All valves and fittings are supplied complete with appropriate gland and tubing collar. To order these components separately, use part numbers listed below. When using plug, collar is not required. Tubing Pressure Caps can be found in Adapter brochure.

Connection Type	Gland	Collar	Plug	Connection Components (Industry Standard)
			 Socket Head Flush Plug version, add "-F" suffix	
F250C (1/4 HP) F375C (3/8 HP) F562C (9/16 HP) F562C40 (9/16 HP)	AGL40 AGL60 AGL90 AGL90	ACL40 ACL60 ACL90 ACL90	AP40 AP60 AP90 AP90	For use in all Parker Autoclave Engineers High Pressure Cone & Thread Fittings, Adapters and Valves up to 60,000 psi

				
F1000C43 (1" HP)	CGLX160	CCLX160	43CP160	1" Medium Pressure collar and gland design is suitable for use in all Parker Autoclave Engineers 1" High Pressure Cone & Thread Fittings, Adapters, and Valves up to 43,000 psi maximum

**Notes:**

To ensure proper fit use Parker Autoclave Engineers tubing.

For gland nut hex sizes and torque values, see "Tools and Installation" brochure.

All Cone and Thread ports MUST utilize weep holes for safety. When weep hole is not available, we offer a gland nut with a "Slotted Male Thread" that provides this safety feature without the need for the separate port. Use suffix "-SMT" with Gland part number when needed.

All PAE High Pressure Fittings and Tubing can be made with materials suitable for NACE/ISO 15156 requirements. As per NACE and ISO-15156, it is contingent on the end user to select this material. As this compatibility limits the use of "cold worked" materials, most of the choices come with significant pressure reductions. Please consult our Technical Brochure where we identify the more popular annealed materials along with the pressure reduction. Our Sour Oil and Gas brochure has a more complete description of the available options for pressures up to 30,000 psi.

**Special Materials:** Special Material Fittings are normally supplied with CW 316 SS Glands and Collars as these parts do not touch flowing (wetted) media. To match the same material as selected for body, use either "-SOG" (Sour Oil or Gas - NACE) or "-AP" (All Parts) suffix. Special material glands and adapter bodies are normally supplied with four flats (square) in place of standard hex. Include option suffix "-H" if hex is required.

If vibration is inherent in the application, please see information on Antivibration Gland Fittings on pages 15 and 16 of this brochure.



Proudly Distributed By

**TRIDENT AUSTRALIA**  
FLUID SYSTEMS & COMPONENTS

**NACE/ISO 15156 Compatibility**

All PAE High Pressure Fittings and Tubing can be made with materials suitable for NACE/ISO 15156 requirements. As per NACE and ISO-15156, it is contingent on the end user to select suitable material for service. As this compatibility limits the use of "cold worked" materials, most material choices come with significant pressure reductions. Please consult our Technical Brochure where we identify the more popular annealed materials along with the pressure reduction.

**NACE Suffix and Special Materials Options:**

"-SOG" (Sour Oil & Gas) suffix converts all pressure containing parts from cold worked 3166 SS to annealed condition material, requires hardness check, and NACE certificate is generated for each part. Pressure reductions of 50% (30,000 psi) are possible.

"-AP" (All Parts) suffix converts all fitting and most valve materials to the selected material. Normally, collar and gland remain as cold worked 316 SS as they are not "wetted" parts. This option does not get the Hardness verification and no NACE certificate is generated.

Contact factory for other pressure/material options.

**90° Elbow: 45° Elbows are available - replace 00 with 45 (ie; CL6645 or 43CL1645)**

Catalog Number	Connection Type	Outside Diameter Tube	Pressure Rating psi (bar)*	Minimum Opening	Dimensions - inches (mm)						Block Thickness
					A	B	C	D Typical	E	F	
CL4400	F250C	1/4 (6.35)	60,000 (4140)	.094 (2.39)	1.00 (25.40)	1.50 (38.10)	0.50 (12.70)	0.63 (16.00)	0.62 (15.75)	0.88 (22.35)	0.75 (19.05)
CL6600	F375C	3/8 (9.53)	60,000 (4140)	.125 (3.18)	1.50 (38.10)	2.00 (50.80)	0.52 (13.21)	0.81 (20.62)	1.00 (25.40)	1.25 (31.75)	1.00 (25.40)
CL9900	F562C	9/16 (7.94)	60,000 (4140)	.188 (4.78)	1.88 (47.75)	2.62 (66.55)	0.81 (20.57)	1.19 (30.23)	1.12 (28.45)	1.88 (47.75)	1.50 (38.10)
40CL9900	F562C40	9/16 (7.94)	40,000 (2760)	.250 (6.35)	1.88 (47.75)	2.62 (66.55)	0.81 (20.57)	1.19 (30.23)	1.12 (28.45)	1.88 (47.75)	1.50 (38.10)
43CL16	F1000C43	1 (25.40)	43,000 (2965)	.438 (11.13)	3.00 (76.20)	4.12 (104.65)	0.72 (18.29)	1.38 (35.05)	2.06 (52.32)	2.06 (52.32)	1.75 (44.45)

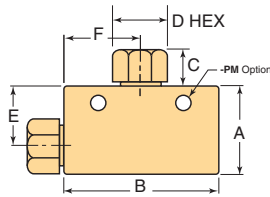

**Note:** Fittings such as 45° elbows, reducer elbows, and reducer 45° elbows are available upon request. For mounting hole option add suffix -PM to catalog number, consult factory for mounting hole dimensions.

\*Maximum pressure rating is based on the lowest rating of any component. Actual working pressure may be determined by tubing pressure rating, if lower. All dimensions for reference only and subject to change. For prompt service, Parker Autoclave Engineers stocks select products. Consult your local representative.

**Tee**

Catalog Number	Connection Type	Outside Diameter Tube	Pressure Rating psi (bar)*	Minimum Opening	Dimensions - inches (mm)						Block Thickness
					A	B	C	D Typical	E	F	
CT4440	F250C	1/4 (6.35)	60,000 (4140)	.094 (2.39)	1.25 (31.75)	2.00 (50.80)	0.50 (12.70)	0.63 (16.00)	0.88 (22.35)	1.00 (25.40)	1.00 (25.40)
CT6660	F375C	3/8 (9.53)	60,000 (4140)	.125 (3.18)	1.56 (39.62)	2.00 (50.80)	0.52 (13.21)	0.81 (20.62)	1.06 (26.92)	1.00 (25.40)	1.00 (25.40)
CT9990	F562C	9/16 (7.94)	60,000 (4140)	.188 (4.78)	2.12 (53.85)	2.62 (66.55)	0.81 (20.57)	1.19 (30.23)	1.38 (35.05)	1.31 (33.27)	1.50 (38.10)
40CT9990	F562C40	9/16 (7.94)	40,000 (2760)	.250 (6.35)	2.12 (53.85)	2.62 (66.55)	0.81 (20.57)	1.19 (30.23)	1.38 (35.05)	1.31 (33.27)	1.50 (38.10)
43CT16	F1000C43	1 (25.40)	43,000 (2965)	.438 (11.13)	3.00 (76.20)	4.12 (104.65)	0.72 (18.29)	1.38 (35.05)	2.06 (52.32)	2.06 (52.32)	1.75 (44.45)

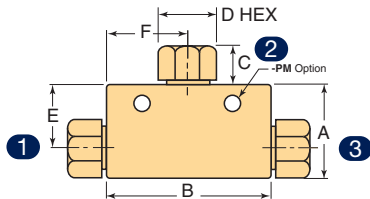

\*Maximum pressure rating is based on the lowest rating of any component. Actual working pressure may be determined by tubing pressure rating, if lower. All dimensions for reference only and subject to change. For mounting hole option add suffix -PM to catalog number. Consult factory for mounting hole dimensions. To order Tee with different size connections of same type, change part number size codes using order shown in drawing, ie: CT6960 would build Tee with 9/16" HP branch and 3/8" HP runs. For Connection Torque requirements please see "Tools and Installation" brochure.



Proudly Distributed By

**TRIDENT** AUSTRALIA  
FLUID SYSTEMS & COMPONENTS

### Cross

Catalog Number	Connection Type	Outside Diameter Tube	Pressure Rating psi (bar)*	Minimum Opening	Dimensions - inches (mm)						Block Thickness
					A	B	C	D Typical	E	F	
CX4444	F250C	1/4 (6.35)	60,000 (4140)	.094 (2.39)	1.25 (31.75)	2.00 (50.80)	0.50 (12.70)	0.63 (16)	0.62 (15.75)	1.00 (25.40)	1.00 (25.40)
CX6666	F375C	3/8 (9.53)	60,000 (4140)	.125 (3.18)	2.12 (53.85)	2.00 (50.80)	0.52 (13.21)	0.81 (21)	1.06 (26.92)	1.00 (25.40)	1.00 (25.40)
CX9999	F562C	9/16 (7.94)	60,000 (4140)	.188 (4.78)	2.75 (69.85)	2.62 (66.55)	0.81 (20.57)	1.19 (31)	1.38 (35.05)	1.31 (33.27)	1.50 (38.10)
40CX9999	F562C40	9/16 (7.94)	40,000 (2760)	.250 (6.35)	2.75 (69.85)	2.62 (66.55)	0.81 (20.57)	1.19 (31)	1.38 (35.05)	1.31 (33.27)	1.50 (38.10)
43CX16	F1000C43	1 (25.40)	43,000 (2965)	.438 (11.13)	4.12 (104.65)	4.12 (104.65)	0.72 (18.29)	1.38 (35)	2.06 (52.32)	2.06 (52.32)	1.75 (44.45)

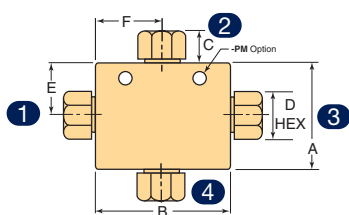

\*Maximum pressure rating is based on the lowest rating of any component. Actual working pressure may be determined by tubing pressure rating, if lower. For prompt service, Parker Autoclave Engineers stocks select products. Consult your local representative. For mounting hole option add suffix -PM to catalog number. Consult factory for mounting hole dimensions. To order Cross with different size connections of same type, change part number size codes using order shown in drawing, ie: CX6969 would build a Cross with 9/16" HP alternating with 3/8" HP. For Connection Torque requirements please see "Tools and Installation" brochure.

### Bulkhead Coupling

Catalog Number	Connection Type	Outside Diameter Tube	Pressure Rating psi (bar)*	Minimum Opening	Dimensions - inches (mm)						
					A	B	C	D Typical	E	F Hex	G Thickness
60BF4433	F250C	1/4 (6.35)	60,000 (4140)	.094 (2.39)	0.94 (23.9)	1.88 (47.75)	0.50 (12.70)	0.63 (16)	0.50 (12.70)	1.00 (25.40)	0.38 (9.65)
60BF6633	F375C	3/8 (9.53)	60,000 (4140)	.125 (3.18)	1.12 (28.45)	2.38 (60.45)	0.53 (13.46)	0.81 (21)	0.78 (19.81)	1.38 (35.05)	0.38 (9.65)
60BF9933	F562C	9/16 (7.94)	60,000 (4140)	.188 (4.78)	1.69 (42.93)	2.75 (69.85)	0.81 (20.57)	1.19 (31)	1.00 (25.40)	1.88 (47.75)	0.38 (9.65)
40BF9933	F562C40	9/16 (7.94)	40,000 (2760)	.250 (6.35)	1.69 (42.93)	2.75 (69.85)	0.81 (20.57)	1.19 (31)	1.00 (25.40)	1.88 (47.75)	0.38 (9.65)
43BF16	F1000C43	1 (25.40)	43,000 (2965)	.438 (11.13)	1.94 (49.28)	3.50 (88.90)	0.72 (18.29)	1.38 (35)	1.50 (38.10)	2.13 (54.10)	0.50 (12.70)

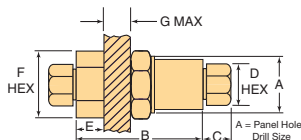

\*Maximum pressure rating is based on the lowest rating of any component. Actual working pressure may be determined by tubing pressure rating, if lower. All dimensions for reference only and subject to change. For prompt service, Parker Autoclave Engineers stocks select products. Consult your local representative.

**Straight Coupling / Union Coupling (see assembly drawing below)**

Catalog Number	Connection Type	Outside Diameter Tube	Pressure Rating psi (bar)*	Minimum Opening	Dimensions - inches (mm)				Coupling Type
					A	B	C	D Typical	
60F4433 60UF4433	F250C	1/4 (6.35)	60,000 (4140)	.094 (2.39)	0.75 (19.05)	1.38 (35.05)	0.50 (12.70)	0.63 (16)	Straight Union
60F6633 60UF6633	F375C	3/8 (9.53)	60,000 (4140)	.125 (3.18)	1.00 (25.40)	1.75 (44.45)	0.53 (13.46)	0.81 (21)	Straight Union
60F9933 60UF9933	F562C	9/16 (7.94)	60,000 (4140)	.188 (4.78)	1.38 (35.05)	2.19 (55.63)	0.81 (20.57)	1.19 (31)	Straight Union
40F9933 40UF9933	F562C40	9/16 (7.94)	40,000 (2760)	.250 (6.35)	1.38 (35.05)	2.19 (55.63)	0.81 (20.57)	1.19 (31)	Straight Union
43F16 43UF16	F1000C43	1 (25.40)	43,000 (2965)	.438 (11.13)	1.75 (44.45)	3.50 (88.90)	0.72 (18.29)	1.38 (35)	Straight Union

**Note:** Union Couplings are designed with a removable seat insert allowing disassembly and tubing removal without the necessity of loosening other items in a line.

\*Maximum pressure rating is based on the lowest rating of any component. Actual working pressure may be determined by tubing pressure rating, if lower. All dimensions for reference only and subject to change. For prompt service, Parker Autoclave Engineers stocks select products. Consult your local representative.

**Union Coupling Assembly**

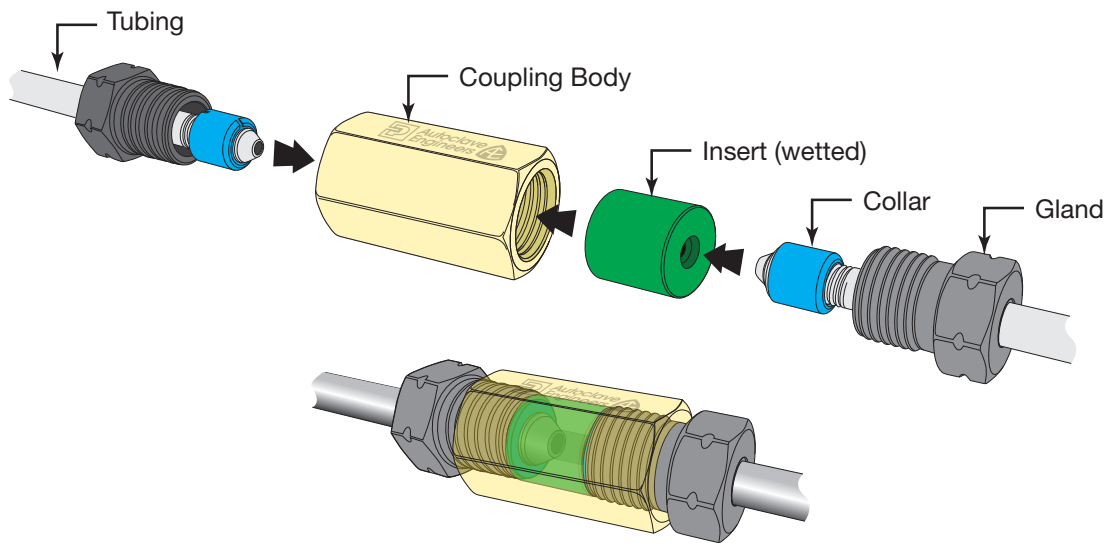

Assembled Union Coupling

**Union vs. Straight Coupling Comparison**

In much the same as with a traditional Pipe Union, the PAE Union Coupling is used to easily disassemble tubing runs when valves or fittings need to be replaced after original installation. The Body and Insert are two different pieces in the same assembly. The body can slide down tubing leaving only the insert and the tubing tips engaged. Then with only minimal tube shift, the insert drops out allowing the tubing to be removed avoiding the need to disassemble multiple tubing sections from closest elbow.

**Note:** When Special Materials are requested, the only material that is changed is the Insert (wetted). If "All Parts" are to be requested, include suffix "-AP" or "-SOG" if for NACE/ISO 15156.



## Tubing

**High Pressure Tubing** - Pressures to 60,000 psi (4140 bar)



Parker Autoclave Engineers offers a complete selection of austenitic cold drawn seamless stainless steel tubing designed to match the performance standards of Parker Autoclave valves and fittings. Parker Autoclave high pressure tubing is manufactured of 316/316L (UNS S31600/S31603) and 304/304L (UNS S30400/S30403) specifically for high pressure applications requiring both strength and corrosion resistance. The tubing is furnished in random lengths between 20 feet (6 meters) and 26.5 feet (8.0 meters). The average is 24 feet (7.3 meters). High pressure tubing is available in five sizes and a variety of materials. Special longer lengths are available. Consult factory.

### Inspection and Testing:

Parker Autoclave Engineer's high pressure tubing is inspected to assure freedom from seams, laps, fissures or other flaws, as well as carburization or intergranular carbide precipitation. The outside and inside diameters of the tubing are controlled within close tolerances including runout. Sample pieces of tubing for each lot are tested to confirm mechanical properties. Hydrostatic testing is also performed on a statistical basis and is conducted at the working pressure of the tube. Parker Autoclave will perform 100% hydrostatic testing up to 1.5 times working pressure at additional cost if desired.

### Special Material:

In addition to the most commonly requested materials we have other material options outlined in our Technical Brochure such as 316 SS (annealed), 6 Moly, Hastelloy C276, and Inconel. These options include materials suitable for use in NACE/ISO 15156 corrosive or stress cracking applications.

### Tubing Tolerance:

Nominal Tubing Size inches (mm)	Tolerance/Outside Diameter inches (mm)
1/4 (6.35)	.248/.243 (6.30/6.17)
3/8 (9.53)	.370/.365 (9.40/9.27)
9/16 (14.29)	.557/.552 (14.15/14.02)
1 (25.40)	.995/.990 (25.27/25.14)

Note:  
Standard Tubing is manufactured in accordance with ASME B31.3 Chapter IX standards using UNS S31600/S31603, 316/316L Stainless Steel material, cold worked to Parker Autoclave proprietary standards.

High Pressure Tubing outside diameter dimensions do not meet standard commercial tubing tolerances. Tubing outside dimensions are specifically chosen to meet tube threading die requirements.

Parker Autoclave Engineers components and tubing are designed as a "complete system" for safety and our fittings will not be compatible with standard "commercial" tubing.

### Autofrettage for High Pressure High Cycle (HPHC) applications:

If high cycle fatigue life is a concern, Parker Autoclave Engineers can supply tubing which has been autofrettaged for improved fatigue resistance. For internally pressurized tubing, **autofrettage** is a method by which the inner wall of the tube is precompressed to reduce the tube operating bore stresses, thereby increasing cycle life and increasing the life span of the tubing. (every application is different and while life span increases of 40% have been reported, we cannot guarantee any specific increase in tubing life.)



Proudly Distributed By

**TRIDENT AUSTRALIA**  
FLUID SYSTEMS & COMPONENTS

### High Pressure Tubing Details: 316/316L & 304/304L Stainless Steel (Cold Worked)

Catalog Number	Tube Material	Fits Connection Type	Tube Size inches (mm)			Flow Area in <sup>2</sup> (mm <sup>2</sup> )	Working Pressure psi (bar)*			
			Outside Diameter	Inside Diameter	Wall Thickness		-423 to 100°F (-252 to 38°C)	200°F (93°C)	400°F (204°C)	600°F (316°C)
MS15-081	316SS	F250C	1/4 (6.35)	0.083 (2.11)	0.083 (2.11)	0.005 (3.23)	60,000 (4140)	60,000 (4140)	57,750 (3982)	54,250 (3740)
MS15-182	304SS						60,000 (4140)	56,800 (3916)	17,200 (1172)	50,700 (3496)
MS15-087	316SS	F375C	3/8 (9.63)	0.125 (3.18)	0.125 (3.18)	0.012 (7.74)	60,000 (4140)	60,000 (4140)	57,750 (3982)	54,250 (3740)
MS15-183	304SS						60,000 (4140)	56,800 (3916)	51,650 (3561)	50,700 (3496)
MS15-083	316SS	F562C	9/16 (14.29)	0.188 (4.78)	0.187 (4.75)	0.028 (18.06)	60,000 (4140)	60,000 (4140)	57,750 (3982)	54,250 (3740)
MS15-185	304SS						60,000 (4140)	56,800 (3916)	51,650 (3561)	50,700 (3496)
MS15-090	316SS	F562C40	9/16 (14.29)	0.250 (6.35)	.156 (3.96)	.048 (30.97)	40,000 (2760)	40,000 (2760)	38,500 (2654)	36,100 (2489)
MS15-211	316SS	F1000C43	1 (25.40)	0.438 (11.13)	.281 (7.14)	0.151 (97.42)	43,000 (2965)	43,000 (2965)	43,000 (2965)	41,380 (2853)

Note:

- Autofrettagged tubing available (see Technical section: Pressure Cycling for explanation of "Autofrettagge").
- For Ultra-High Pressure, High Cycle (HPHC) tubing above 60,000 psi, see Parker Autoclave Engineers Ultra High Pressure Fittings and Tubing Brochure.
- See Technical Section for Temperature Ratings over 600°F (315°C).

\*Maximum pressure rating is based on the lowest rating of any component. Actual working pressure may be determined by tubing pressure rating, if lower. All dimensions for reference only and subject to change. For prompt service, Parker Autoclave Engineers stocks select products. Consult your local representative.

### High Pressure Connection: Step by Step Assembly Instructions

Step 1	Step 2	Step 3												
<p>Insert Coned and Threaded Nipple through Gland</p> <p>(Typical Tee Fitting Assembly consisting of Fitting Body, Collar, Gland, and Coned and Threaded Nipple or Tube End.)</p>	<p>Thread Collar turning (Reverse Threaded to prevent rotation during torque process) onto Coned and Threaded Nipple end.</p>	<p>For proper Collar placement, thread Collar onto Nipple leaving 1 to 2 full threads exposed on Fitting side of Collar. Lubricate Gland Threads with anti-seize compound and tube tip with process compatible lubricant (do not use metal-flake type)</p>												
Step 4	Step 5	High Pressure Gland Torque												
		<p>For 316/316L SS, 2507 Super Duplex Tubing &amp; Adapters</p> <table border="1"> <thead> <tr> <th>Fitting Size</th> <th>Required Torque ft-lb (N.m)</th> </tr> </thead> <tbody> <tr> <td>1/4" HP</td> <td>25 (34)</td> </tr> <tr> <td>3/8" HP</td> <td>50 (68)</td> </tr> <tr> <td>9/16" HP</td> <td>75 (102)</td> </tr> <tr> <td>9/16" HP-40Ksi</td> <td>60 (82)</td> </tr> <tr> <td>1" HP-43Ksi</td> <td>180 (244)</td> </tr> </tbody> </table> <p>For torques and optional materials (lower pressures), see Tools and Installation Catalog 02-0149SE</p> <p>*1" Connection will have collar in front of gland nut but assembles with same process.</p>	Fitting Size	Required Torque ft-lb (N.m)	1/4" HP	25 (34)	3/8" HP	50 (68)	9/16" HP	75 (102)	9/16" HP-40Ksi	60 (82)	1" HP-43Ksi	180 (244)
Fitting Size	Required Torque ft-lb (N.m)													
1/4" HP	25 (34)													
3/8" HP	50 (68)													
9/16" HP	75 (102)													
9/16" HP-40Ksi	60 (82)													
1" HP-43Ksi	180 (244)													
<p>Insert Tube/Gland assembly into Fitting body, turning clockwise approximately 4-5 threads (if unable to turn full distance by hand, look for misalignment issues with tubing and correct for proper seal).</p>	<p>Use Torque Wrench to properly set (see chart in next frame) Cone &amp; Thread Connections. (Available with wrench adapters in Tools and Installation brochure)</p>													



Proudly Distributed By

TRIDENT AUSTRALIA  
FLUID SYSTEMS & COMPONENTS

# Coned-and-Threaded Nipples

High Pressure - Pressures to 60,000 psi (4140 bar)

For rapid system make-up, Parker Autoclave Engineers supplies pre-cut, coned-and-threaded nipples in various sizes and lengths for Parker Autoclave Engineers medium pressure valves and fittings.



## Special Lengths:

In addition to the standard lengths listed in the table below, nipples are available in any custom length. Consult factory.

## Material:\*\*

Catalog numbers in table refer to Type UNS S31600/ S31603, CW 316/316L Stainless steel. Optional materials available. Consult factory.

## Nipple Details:

Catalog Number (316 Stainless Steel)					
Tube Size inches (mm)	Fits Connection Type				
	F250C	F375C	F562C	F562C40	F1000C43
Outside Diameter	1/4 (6.35)	3/8 (9.53)	9/16 (14.29)	9/16 (14.29)	1 (25.40)
Inside Diameter	.083 (2.11)	.125 (3.18)	.188 (4.78)	.250 (6.35)	.438 (12.409)
Working Pressure at 100°F (38°C) psi (bar)*	60,000 (4140)	60,000 (4140)	60,000 (4140)	40,000 (2760)	43,000 (2965)
Nipple Length inches (mm)					
2.75" (69.85)	CN4402-316				
3.00" (76.20)	CN4403-316	CN6603-316			
4.00" (101.60)	CN4404-316	CN6604-316	CN9904-316	40CN9904-316	
6.00" (152.40)	CN4406-316	CN6606-316	CN9906-316	40CN9906-316	43CN1606-316
8.00" (203.20)	CN4408-316	CN6608-316	CN9908-316	40CN9908-316	43CN1608-316
10.00" (254.00)	CN44010-316	CN66010-316	CN99010-316	40CN99010-316	43CN16010-316
12.00" (304.80)	CN44012-316	CN66012-316	CN99012-316	40CN99012-316	43CN16012-316
14.00" (355.60)	CN44014-316	CN66014-316	CN99014-316	40CN99014-316	43CN16014-316
16.00" (406.40)	CN44016-316	CN66016-316	CN99016-316	40CN99016-316	43CN16016-316
18.00" (457.20)	CN44018-316	CN66018-316	CN99018-316	40CN99018-316	43CN16018-316
20.00" (508.00)	CN44020-316	CN66020-316	CN99020-316	40CN99020-316	43CN16020-316
22.00" (558.80)	CN44022-316	CN66022-316	CN99022-316	40CN99022-316	43CN16022-316
24.00" (609.60)	CN44024-316	CN66024-316	CN99024-316	40CN99024-316	43CN16024-316

### Notes:

See High Pressure Tubing section of this brochure or Technical Brochure for pressure ratings at various temperatures.

\* Maximum pressure rating is based on the lowest rating of any component. Actual working pressure may be determined by tubing pressure rating, if lower.

\*\* Type 304 Stainless Steel nipples available.

\*\*\* 40CN99XX nipples use the larger bore (0.250") 9/16" tubing rated at 40,000 psi with standard HP collars and glands.

All dimensions for reference only and subject to change. For prompt service, Parker Autoclave Engineers stocks select products. Consult your local representative.



# Check Valves

**High Pressure** - Pressures to 60,000 psi (4140 bar)

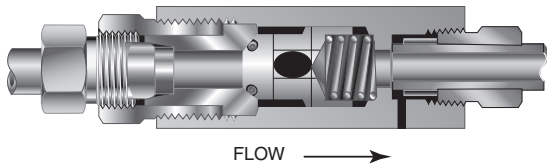

## CKO Series O-Ring Check Valve

Ordering part numbers can be found on page 12

Provide unidirectional flow and tight shut-off for liquids and gases with high reliability. When differential drops below cracking pressure\*, valve shuts off. **(Not for use as relief valve.)**

**Cracking Pressure\***: 20 psi (1.38 bar) ±30%. Springs for higher cracking pressures up to 100 psi available on special order for O-ring style check valves only.

### Temperature Range/O-ring Options:

Viton (FKM) O-ring (std.): 0° to 400°F (-18° to 204°C)

Buna-N O-ring (-**BO** suffix): -20° to 250°F (-29° to 121°C)

FFKM O-ring (-**KO** suffix): 30° to 500°F \*(-18° to 260°C)

PTFE O-ring (-**TO** suffix): -100° to 400°F (-73° to 204°C)

PTFE O-ring with Low Temp Spring (-**LTTO** suffix): to -423°F (-252°C)

### Installation:

Vertical or Horizontal as required. Flow Direction arrow on valve body.

**CAUTION:** While testing has shown O-Rings to provide satisfactory service life, both cyclic and shelf life may vary widely with differing service conditions, properties of reactants, pressure and temperature cycling and age of the O-ring.

**FREQUENT INSPECTIONS SHOULD BE MADE** to detect any deterioration, and O-rings replaced as required.

**NOTE:** For optional material see Technical Brochure. Special material check valves are normally supplied with four flats in place of standard hex.

## Material of Construction:

Item #	Description	Material
1	Check Valve Body	316 SS
2	Cover	316 SS
3	Poppet	316 SS
4	Gland Nut	316 SS
5	Spring	302 SS
6	O-Ring	90 Duro FKM

Typical spare parts found in Repair Kits

### Basic O-ring Check Valve Repair Kits:

Check Valves are easily repaired. Add "**R**" to front of valve catalog number for proper repair kit (example: RCKO9900) See "Cover Torque" on page 12 for re-assembly. Include any catalog number suffix marked on original part when ordering repair kit.

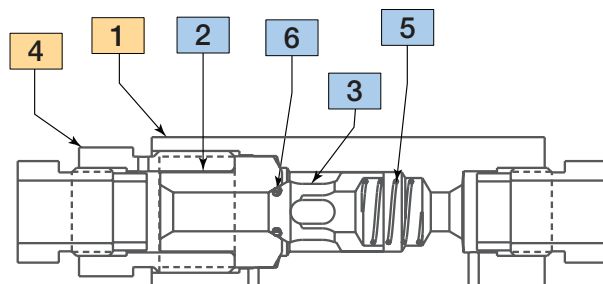



Proudly Distributed By

**TRIDENT** AUSTRALIA  
FLUID SYSTEMS & COMPONENTS

# Check Valves

**High Pressure** - Pressures to 60,000 psi (4140 bar)

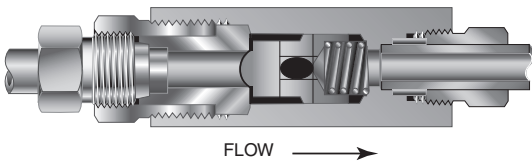

## CB Series Ball Check Valve

Ordering part numbers can be found on page 12

Prevent reverse flow **where leak-tight shut-off is not mandatory**. When differential drops below cracking pressure, valve closes. With all-metal components, valve can be used up to 800°F (425°C). See Technical Information section for connection temperature limitations. **(Not for use as relief valve.)**

**Ball and poppet are an integral design** to assure positive, in-line seating without “chatter”. Poppet is designed essentially for axial flow with minimum pressure drop.

**Cracking Pressure\***: 20 psi (1.38 bar) +/- 30% No optional cracking pressures available.

**Temperature Range**: With All-Metal components, valve can be used to 800°F (425°C). Minimum standard operating temperature is -110°F (-79°C). For Low Temperature operation to -423°F (-252°C) use suffix “-LT” (Low Temp Spring)

### Installation:

Vertical or Horizontal as required. Flow Direction arrow on valve body.

**NOTE**: For optional material see Technical Brochure. Special material check valves are normally supplied with four flats in place of standard hex.

## Material of Construction:

Item #	Description	Material
1	Gland	316 SS
2	Gland Nut	316 SS
3	Cover	316 SS
4	Poppet	316 SS
5	Spring	302 SS
6	Check Valve Body	316 SS

Typical spare parts found in Repair Kits

### Basic Ball Check Valve Repair Kits:

Check Valves are easily repaired. Add “R” to front of valve catalog number for proper repair kit (example: RCB9901) See “Cover Torque” on page 12 for re-assembly.

Include any catalog number suffix marked on original part when ordering repair kit.

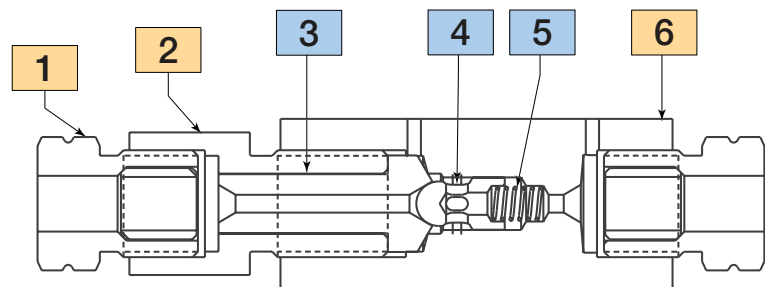



Proudly Distributed By

**TRIDENT** AUSTRALIA  
FLUID SYSTEMS & COMPONENTS

# Excess Flow Valves

**High Pressure** - Pressures to 60,000 psi (4140 bar)

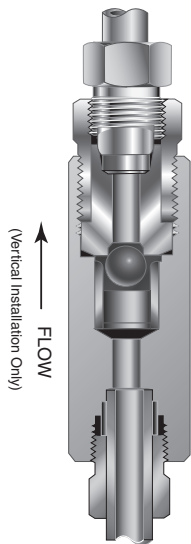

Protects pressure gauges and pressure instrumentation from sudden surges in flow or venting in the event of line failure.

**Vertical Installation:** Since this type of check valve employs a non-spring loaded ball, valve **MUST** be installed in **VERTICAL** position with arrow on valve body pointing **UP**. (cover gland up).

**Resetting Valve:** Equalize the pressure across the ball. The ball will drop and reset automatically. Note: when in checked position, a small flow is permitted through the valve.

**Temperature Range:** With All-Metal components, Excess Flow Valve can be used from -423° to 800°F (-252° to 425°C).

**NOTE:** For optional material see Technical Brochure. Special material check valves are normally supplied with four flats in place of standard hex.

## CK Series Ball Type Excess Flow Valves (Surge Check)

Ordering part numbers can be found on page 12

### Material of Construction:

Item #	Description	Material
1	Gland Nut	316 SS
2	Cover	316 SS
3	Ball, 1/2" Diameter	302 SS
4	Check Valve Body	316 SS

Typical spare parts found in Repair Kits

#### Excess Flow Valve Repair Kits

Excess Flow Valves are easily repaired. Add "R" to front of valve catalog number for proper repair kit (example: RCK9902) See "Cover Torque" on page 12 for re-assembly. Include any catalog number suffix marked on original part when ordering repair kit.

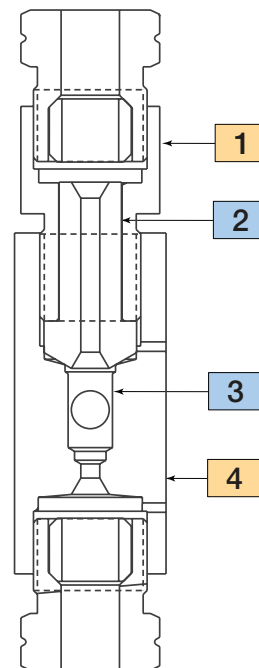



Proudly Distributed By

**TRIDENT AUSTRALIA**  
FLUID SYSTEMS & COMPONENTS

### O-Ring Check Valves

Catalog Number	Fits Connection Type	Pressure Rating psi (bar)**	Orifice inches (mm)	Rated Cv	Cover Gland Torque ft. lb (Nm)	Dimensions - inches (mm)				
						A	B	C	D Typical	Hex
CKO4400	F250C	60,000 (4140)	.094 (2.39)	.15	110 (150)	3.38 (85.85)	2.50 (63.50)	0.50 (12.70)	0.63 (16)	1.18 (30)
CKO6600	F375C	60,000 (4140)	.125 (3.184)	.28	110 (150)	3.75 (95.25)	2.62 (66.55)	0.53 (13.46)	0.75 (19)	1.18 (40)
CKO9900	F562C	60,000 (4140)	.187 (4.75)	.63	160 (220)	4.62 (117.35)	3.38 (85.85)	0.81 (20.57)	1.12 (28)	1.50 (38)
40CKO9900	F562C40	40,000 (2758)	.250 (6.35)	.78	185 (250)	4.64 (117.86)	3.38 (85.73)	0.72 (18.29)	1.19 (30)	1.50 (38)
43CKO16	F1000C43	43,000 (2965)	.438 (11.13)	4.3	530 (720)	6.54 (166.11)	5.63 (143.00)	0.72 (18.29)	1.38 (35)	1.88† (48)

### Ball Check Valves

CB4401	F250C	60,000 (4140)	.094 (2.39)	.15	110 (150)	3.38 (85.85)	2.50 (63.50)	0.50 (12.70)	0.63 (16)	1.18 (30)
CB6601	F375C	60,000 (4140)	.125 (3.18)	.28	110 (150)	3.75 (95.25)	2.62 (66.55)	0.53 (13.46)	0.75 (19)	1.18 (30)
CB9901	F562C	60,000 (4140)	.187 (4.75)	.63	160 (220)	4.62 (117.35)	3.38 (85.85)	0.81 (20.57)	1.12 (28)	1.50 (38)
40CB9901	F562C40	40,000 (2558)	.250 (6.35)	.78	185 (250)	4.64 (117.86)	3.38 (85.85)	0.72 (18.29)	1.19 (30)	1.50 (38)
43CB16	F1000C43	43,000 (2965)	.438 (11.13)	4.3	530 (720)	6.54 (166.11)	5.63 (143.00)	0.72 (18.29)	1.38 (35)	1.88† (48)

### Ball Type Excess Flow Valves (Surge Check)

CK4402	F250C	60,000 (4140)	.094 (2.39)		110 (150)	3.38 (85.85)	2.50 (63.50)	0.50 (12.70)	0.63 (16)	1.18 (30)
CK6602	F375C	60,000 (4140)	.125 (3.18)		110 (150)	3.75 (95.25)	2.62 (66.55)	0.53 (13.46)	0.75 (19)	1.18 (30)
CK9902	F562C	60,000 (4140)	.187 (4.75)		160 (220)	4.62 (117.35)	3.38 (85.85)	0.81 (20.57)	1.12 (29)	1.50 (38)

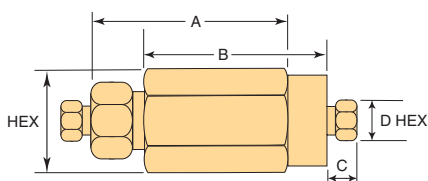

Note:

† Distance across flats

\*\* Maximum pressure rating is based on the lowest rating of any component. Actual working pressure may be determined by tubing pressure rating, if lower. All dimensions for reference only and subject to change. For prompt service, Parker Autoclave stocks select products. Consult your local representative.

Check and Excess Flow Valve Dimensions

# Line Filters

**High Pressure** - Pressures to 60,000 psi (4137 bar)

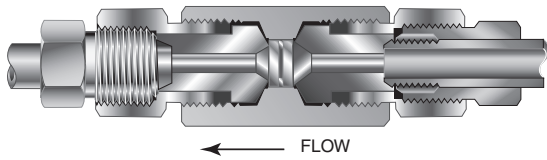

**CFL Series  
Dual Disc Line Filters**

Dual-Disc Line Filters are utilized in numerous industrial, chemical processing, aerospace, nuclear and other applications. With the dual-disc design, large contaminant particles are trapped by the upstream filter element before they can reach and clog the smaller micron-size downstream element. Filter elements can be easily replaced.

**Materials:** Body, Cover, Gland Nut: CW 316 Stainless Steel.

**Filter Element:** 316L Stainless Steel, Sintered Disc Type. Downstream/upstream micron size 35/65 is standard. 5/10 or 10/35 also available when specified. Other element combinations available on special order.

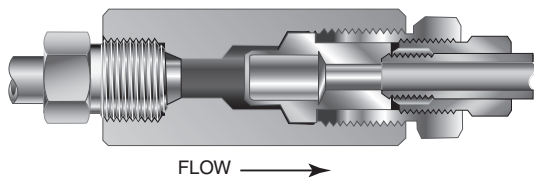

**CF Series  
Cup Type Line Filters**

High Flow Cup-Type Line Filters are recommended in high pressure systems requiring both high flow rates and maximum filter surface area. Widely used in the industrial and chemical processing fields, the cup design offers as much as six times the effective filter area as compared to disc-type units. In addition, the filter elements can be quickly and easily replaced.

**Materials:** Body, Cover, Gland Nut: CW 316 Stainless Steel.

**Filter Element:** 316L Stainless Steel, Sintered Cup Type. Standard elements available in choice of 5, 35 or 65 micron sizes. Note: Filter ratings are nominal.

**Temperature Range:** Both Models: Oxidizing Fluids: 750°F (400°C) maximum Non-Oxidizing Fluids: 900°F (480°C) -423°F (-252°C) minimum

**Spare Parts:** Filter Elements are only replaceable part with either filter type. See chart on page 14 for Filter Element part numbers.

NOTE 1: All filters furnished complete with connection components unless otherwise specified. All dimensions for reference only and subject to change. For optional materials, see Technical Section

NOTE 2: Parker Autoclave Engineers disc and cup type filters are designed to filter small amounts of process particles. It is recommended that all fluids are thoroughly cleaned prior to entering the higher pressure system.

NOTE 3: Special material filters may be supplied with four flats in place of standard hex.

NOTE 4: Pressure differential not to exceed 1,000 psi (69 bar) in a flowing condition. Filter Replacement is recommended.

NOTE 5: Larger micron size filter element is installed on the upstream (inlet) side.



Proudly Distributed By

**TRIDENT** AUSTRALIA  
FLUID SYSTEMS & COMPONENTS

### Dual Disc Line Filters: High Pressure, 60,000 psi (4140 bar)

Catalog Number	Orifice inches (mm)	Micron Size**	Replacement Filter P/N	Cover Gland Torque ft. lb (Nm)	Effective Filter Elements Area in <sup>2</sup> (mm <sup>2</sup> )	Dimensions - inches (mm)				
						A	B	C	D Typical	Hex
CLF4400	.094 (2.39)	35/65	65um = P-0803	80 (110)	0.07 (45.16)	4.75 (20.66)	3.00 (76.20)	0.50 (12.70)	0.63 (16)	1.12 (28)
CLF4400-5/10		5/10	35um = P-0804							
CLF4400-10/35		10/35	10um = P-1738 5um = P-1028							
CLF6600	.125 (3.18)	35/65	65um = P-0803	120 (160)	0.07 (45.16)	5.12 (130.16)	3.00 (76.20)	0.53 (13.46)	0.75 (19)	1.12 (28)
CLF6600-5/10		5/10	35um = P-0804							
CLF6600-10/35		10/35	10um = P-1738 5um = P-1028							
CLF9900	.187 (4.76)	35/65	65um = P-0650	150 (200)	0.15 (96.77)	5.81 (147.67)	3.38 (86.66)	0.81 (20.68)	1.12 (28)	1.38 (35)
CLF9900-5/10		5/10	35um = P-0805							
CLF9900-10/35		10/35	10um = P-1785 5um = P-1650							

### Cup Type Line Filters: High Pressure, 60,000 psi (4140 bar)

CF4-5	.094 (2.39)	5	240A-2916	125 (170)	1.29 (832.26)	4.19 (106.42)	3.38 (85.85)	0.50 (12.70)	0.63 (16)	1.38 (35)
CF4-35		35	241A-2916							
CF4-65		65	242A-2916							
CF6-5	.125 (3.18)	5	240A-2916	125 (170)	1.29 (832.26)	4.62 (117.35)	3.62 (91.94)	0.53 (13.46)	0.75 (19)	1.38 (35)
CF6-35		35	241A-2916							
CF6-65		65	242A-2916							
CF9-5	.187 (4.76)	5	240A-2916	110 (150)	1.29 (832.26)	5.25 (133.35)	4.06 (103.12)	0.81 (20.58)	1.12 (28)	1.50 (38)
CF9-35		35	241A-2916							
CF9-65		65	242A-2916							

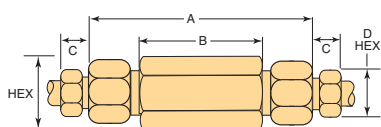

Dual Disc Line Filter Dimensions

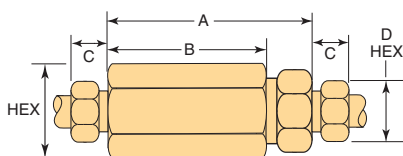

Cup Type Line Filter Dimensions

For optional materials, see Needle Valve Options section.

\*Maximum pressure rating is based on the lowest rating of any component.

Actual working pressure may be determined by tubing pressure rating, if lower. All dimensions for reference only and subject to change.

For prompt service, Parker Autoclave Engineers stocks select products. Consult your local representative.



Proudly Distributed By

**TRIDENT** AUSTRALIA  
FLUID SYSTEMS & COMPONENTS

# Anti-Vibration Collet Gland Assembly

Series KCGL High Pressure - Pressures to 60,000 psi (4140 bar)

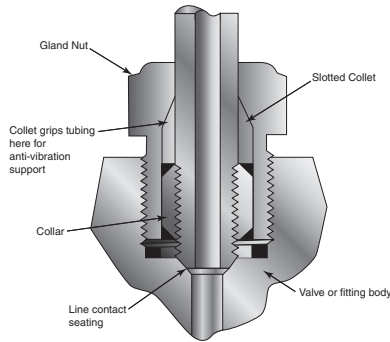

**Series KCGL**  
60,000 psi (4137 bar)

**Note:**

- 1) To order valve and fitting components with anti-vibration assemblies add -K to catalog numbers.
- 2) Special material assemblies are normally supplied with four flats in place of standard hex.
- 3) See Tools and Installation Catalog for Installation Instructions including Torque Specifications.

## Series KCGL (sizes to 9/16" (14.29 mm))

For extreme conditions of vibration and/or shock in tubing systems, such as locating valve or fitting on an unsupported line near a compressor, Parker Autoclave Engineers coned-and-threaded connections are offered with the Anti-Vibration Collet Gland Assemblies. Completely interchangeable with standard Parker Autoclave Engineers high pressure connections, the Collet Gland Assemblies provide equally effective pressure handling capability.

In standard connection systems, the bending stresses on the threaded area of the tubing imposed by excessive vibration or movement may cause premature fatigue failure of the tubing at the back of the thread. By moving the stress concentration back to the unthreaded part of the tubing and providing a wedge-type gripping action, the Parker Autoclave Engineers anti-vibration collet gland assembly strengthens the entire structure. With stress concentration reduced and overall stress level maintained well below the endurance limit of the material, the result is extended vibrational fatigue life.

A less complex and more economical design than other vibration-resistant connections, the Collet Gland Assembly utilizes the same coned-and-threaded features of Parker Autoclave Engineers high pressure connections. In Series KCGL the gland nut is recessed to accommodate a tapered, slotted collet that grips the tubing at a point behind the threaded area of the tubing. The design provides a slight difference in angles between the collet and the corresponding taper of the gland nut. As the nut is tightened, it acts to wedge the tapered end of the collet into a gripping engagement with the tubing and, at the same time, forces the collar and tubing assembly into line contact with the connection seat.

## Anti-Vibration Collet Gland Assembly Details:

Catalog Number	Part	Outside Diameter Tubing Size Inches (mm)	Dimensions: Inches (mm)		
			A	B	Hex
KCGL40-316	Complete Assembly	1/4 (6.35)	0.50 (12.70)	0.81 (20.58)	5/8 (16)
KCGL60-316	Complete Assembly	3/8 (9.53)	0.62 (15.75)	1.12 (28.45)	13/16 (21)
KCGL90-316	Complete Assembly	9/16 (14.29)	1.00 (25.40)	1.50 (38.10)	1-3/16 (30)

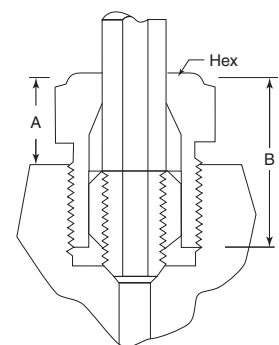

**Series KCGL**  
60,000 psi (4140 bar)

Standard Parker Autoclave Engineers collar not included in Antivibration Gland assembly (chart) if AV Gland ordered separately.

All dimensions for reference only and subject to change.  
For prompt service, Parker Autoclave Engineers stocks select products. Consult your local representative.



Proudly Distributed By

**TRIDENT** AUSTRALIA  
FLUID SYSTEMS & COMPONENTS

# Anti-Vibration Collet Gland Assembly

Series KCBGLX High Pressure - 1" Only to 43,000 psi (2965 bar)

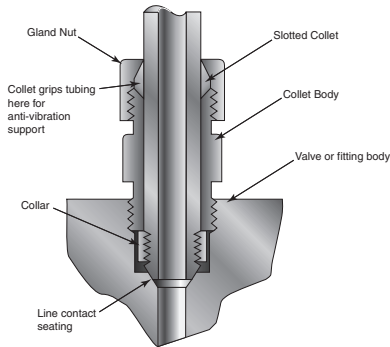

**Series KCBGLX (1" only)**  
Pressures to 43,000 psi (2965 bar)

## Series KCBGLX: 1" High Pressure (compatible with F1000C43 connection)

The 1" High Pressure Fittings and Valves utilize the 1" Medium Pressure Gland and Collar to secure the tubing into the connection. As such the Antivibration Gland assembly has a slightly different design from the typical "High Pressure" connection and has the collar in front of the gland nut.

Series KCBGLX extends the gland nut to provide room for the tapered, slotted collet and collet nut. The design provides a slight difference in angles between the collet and the corresponding taper of the gland nut. As the nut is tightened, it acts to wedge the tapered end of the collet into a gripping engagement with the tubing.

## Material

316 SS with bonded dry film molybdenum disulfide to help prevent galling. Additional thread lubricant not needed.

### Note:

- 1) To order valve and fitting components with anti-vibration assemblies add **-K** to catalog numbers.
- 2) Special material assemblies are normally supplied with four flats in place of standard hex.
- 3) See Tools and Installation Catalog for Installation Instructions including Torque Specifications.

## 1" Anti-Vibration Collet Gland Assembly Details:

Catalog Number	Part	Outside Diameter Tubing Size Inches (mm)	Dimensions: Inches (mm)		
			A	B	Hex
KCBGLX160-316MC	Complete Assembly	1.0 (25.40)	1.69 (25.40)	2.38 (60.45)	1-1/2" (38)
<p>All dimensions for reference only and subject to change. For prompt service, Parker Autoclave Engineers stocks select products. Consult your local representative.</p>					

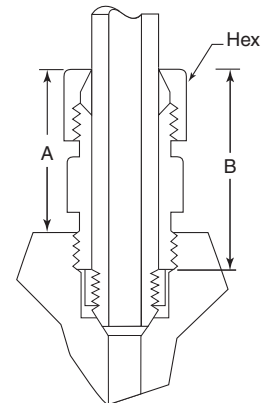

**Series KCBGLX**  
Pressures to 43,000 psi (2965 bar)

Standard Parker Autoclave Engineers collar not included in complete assembly if ordered separately.

Always use back-up wrench on collet body when tightening collet gland nut to prevent over-torquing connection.





Proudly Distributed By



NOTES:

---

---

---

---

---

---

---

---

---

---

---

---

---

---

---

---

---

---

---

---

---

---

---

---



High Pressure  
Valves • Fittings • Tubing  
to 150,000 psi.



Reactors • Vessels  
Instrumentation

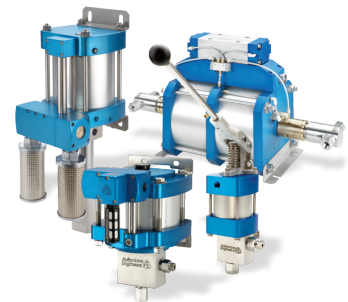

Air Driven, High Flow,  
High Pressure Liquid Pumps

**THIS IS PARKER**

# Parker's Motion & Control Technologies

At Parker, we're guided by a relentless drive to help our customers become more productive and achieve higher levels of profitability by engineering the best systems for their requirements. It means looking at customer applications from many angles to find new ways to create value. Whatever the motion and control technology need, Parker has the experience, breadth of product and global reach to consistently deliver. No company knows more about motion and control technology than Parker. For further information call 1-800-C-Parker.

MARKET	KEY MARKETS	KEY PRODUCTS		
 <b>AEROSPACE</b>	Aircraft Engines Commercial Commerical Transports Military Aircraft Regional Transports	Business and General Aviation Land-Based Weapons Systems Missiles and Launch Vehicles Unmanned Aerial Vehicles	Flight Control Systems & Components Fluid Conveyance Systems Fluid Metering Delivery & Atomization Devices Fuel Systems & Components	Hydraulic Systems & Components Inert Nitrogen Generating Systems Pneumatic Systems & Components Wheels & Brakes
 <b>CLIMATE CONTROL</b>	Agriculture Food, Beverage and Dairy Precision Cooling Transportation	Air Conditioning Life Sciences & Medical Processing	Co2 Controls Electronic Controllers Filter Driers Hand Shut-Off Valves Hose & Fittings	Pressure Regulating Valves Refrigerant Distributors Safety Relief Valves Solenoid Valves Thermostatic Expansion Valves
 <b>ELECTRO-MECHANICAL</b>	Aerospace Life Science & Medical Packaging Machinery Plastics Machinery & Converting Semiconductor & Electronics Factory Automation	Machine Tools Paper Machinery Primary Metals Textile Wire & Cable	AC/DC Drives & Systems Electric Actuators, Gantry Robots & Slides Electrohydraulic Actuation Systems Electromechanical Actuation Systems Human Machine Interface	Linear Motors Stepper Motors, Servo Motors Drives & Controls Structural Extrusions
 <b>FILTRATION</b>	Food & Beverage Life Sciences Mobile Equipment Power Generation Transportation	Industrial Machinery Marine Oil & Gas Process	Analytical Gas Generators Compressed Air & Gas Filters Condition Monitoring Engine Air, Fuel & Oil Filtration & Systems	Hydraulic, Lubrication & Coolant Filters Process, Chemical, Water Microfiltration Filters Nitrogen, Hydrogen & Zero Air Generators
 <b>FLUID and GAS HANDLING</b>	Aerospace Agriculture Bulk Chemical Handling Construction Machinery Food & Beverage Fuel & Gas Delivery	Industrial Machinery Mobile Oil & Gas Transportation Welding	Brass Fittings & Valves Diagnostic Equipment Fluid Conveyance Systems Industrial Hose	PTFE & PFA Hose, Tubing & Plastic Fittings Rubber & Thermoplastic Hose & Couplings Tube Fittings & Adapters Quick Disconnects
 <b>HYDRAULICS</b>	Aerospace Aerial lift Agriculture Construction Machinery Forestry	Industrial Machinery Mining Oil & Gas Power Generation & Energy Truck Hydraulics	Diagnostic Equipment Hydraulic Cylinders & Accumulators Hydraulic Motors & Pumps Hydraulic Systems Hydraulic Valves & Controls	Power Take-Offs Rubber & Thermoplastic Hose & Couplings Tube Fittings & Adapters Quick Disconnects
 <b>PNEUMATICS</b>	Aerospace Conveyor & Material Handling Factory Automation Life Science & Medical	Machine Tools Packaging Machinery Transportation & Automotive	Air Preparation Brass Fittings & Valves Manifolds Pneumatic Accessories Pneumatic Actuators & Grippers Pneumatic Valves & Controls	Quick Disconnects Rotary Actuators Rubber & Thermoplastic Hose & Couplings Structural Extrusions Thermoplastic Tubing & Fittings Vacuum Generators, Cups & Sensors
 <b>PROCESS CONTROL</b>	Chemical & Refining Food, Beverage & Dairy Medical & Dental	Microelectronics Oil & Gas Power Generation	Analytical Sample Conditioning Products & Systems Fluoropolymer Chemical Delivery Fittings, Valves & Pumps High Purity Gas Delivery Fittings, & Valves & Regulators	Instrumentation Fittings, Valves Regulators Medium Pressure Fittings & Valves Process Control Manifolds
 <b>SEALING and SHIELDING</b>	Aerospace Chemical Processing Consumer Energy, Oil & Gas Fluid Power General Industrial	Information Technology Life Sciences Military Semiconductor Transportation	Dynamic Seals Elastomeric O-Rings Emi Shielding Extruded & Precision-Cut, Fabricated Elastomeric Seals	Homogeneous & Inserted Elastomeric Shapes High Temperature Metal Seals Metal & Plastic Retained Composite Seals Thermal Management

## Parker Worldwide

### North America

**USA** – Corporate, Cleveland, OH  
Tel: +1 256 896 3000

**USA** – IPD, Huntsville, AL  
Tel: +1 256 881 2040  
ipdctc@parker.com

**USA** – IPD, (Autoclave), Erie, PA  
Tel: +1 814 860 5700  
ipdaecc@parker.com

**CA** – Canada, Grimsby, Ontario  
Tel: +1 905-945-2274  
ipd\_canada@parker.com

### South America

**AR** – Argentina, Buenos Aires  
Tel: +54 3327 44 4129  
falecom@parker.com

**BR** – Brazil, Diadema, SP  
Diadema, SP  
Tel: +55 11 4360 6700  
falecom@parker.com

**CL** – Chile, Santiago  
Tel: +56 (0) 2 2303 9640  
falecom@parker.com

**MX** – Mexico, Toluca  
Tel: +52 722 275 4200  
contacto@parker.com

### Asia Pacific

**AU** – Australia, Dandenong  
Tel: +61 (0)2 9842 5150  
customer.service.au@parker.com

**CN** – China, Shanghai  
Tel: +86 21 2899 5000  
INGtechnical.china@parker.com

**HK** – Hong Kong  
Tel: +852 2428 8008

**IN** – India, Mumbai  
Tel: +91 22 6513 7081-85

**ID** – Indonesia, Tangerang  
Tel: +62 2977 7900  
parker.id@parker.com

**JP** – Japan, Tokyo  
Tel: +(81) 3 6365 4020  
infopjh@parker.com

**KR** – South Korea, Seoul  
Tel: +82 2 559 0400  
parkerkr@parker.com

**MY** – Malaysia, Selangor  
Tel: +603 784 90 800  
parkermy@parker.com

**SG** – Singapore,  
Tel: +65 6887 6300  
parker.sg@parker.com

**TH** – Thailand, Bangkok  
Tel: +66 2 186 7000  
phthailand@parker.com

**TW** – Taiwan, Taipei  
Tel: +886 2 2298 8987  
enquiry.taiwan@parker.com

**VN** – Vietnam, Hochi Minh City  
Tel: +848 382 508 56  
parker\_viet@parker.com

### Europe, Middle East, Africa

**AE** – UAE, Dubai  
Tel: +971 4 812 7100  
parker.me@parker.com

**AT** – Austria, Wiener Neustadt  
Tel: +43 (0)2622 23501-0  
parker.austria@parker.com

**AT** – Eastern Europe, Wiener Neustadt  
Tel: +43 (0)2622 23501 900  
parker.easteurope@parker.com

**AZ** – Azerbaijan, Baku  
Tel: +994 50 2233 458  
parker.azerbaijan@parker.com

**BE/LU** – Belgium, Nivelles  
Tel: +32 (0)67 280 900  
parker.belgium@parker.com

**BG** – Bulgaria, Sofia  
Tel: +359 2 980 1344  
parker.bulgaria@parker.com

**BY** – Belarus, Minsk  
Tel: +48 (0)22 573 24 00  
parker.belarus@parker.com

**CH** – Switzerland, Etoy  
Tel: +41 (0) 21 821 87 00  
parker.switzerland@parker.com

**CZ** – Czech Republic, Klecany  
Tel: +420 284 083 111  
parker.czechrepublic@parker.com

**DE** – Germany, Kaarst  
Tel: +49 (0)2131 4016 0  
parker.germany@parker.com

**DK** – Denmark, Ballerup  
Tel: +45 43 56 04 00  
parker.denmark@parker.com

**ES** – Spain, Madrid  
Tel: +34 902 33 00 01  
parker.spain@parker.com

**FI** – Finland, Vantaa  
Tel: +358 (0)20 753 2500  
parker.finland@parker.com

**FR** – France, Contamine s/Arve  
Tel: +33 (0)4 50 25 80 25  
parker.france@parker.com

**GR** – Greece, Athens  
Tel: +30 210 933 6450  
parker.greece@parker.com

**HU** – Hungary, Budapest  
Tel: +36 223 885 470  
parker.hungary@parker.com

**IE** – Ireland, Dublin  
Tel: +353 (0)1 466 6370  
parker.ireland@parker.com

**IT** – Italy, Corsico (MI)  
Tel: +39 02 45 19 21  
parker.italy@parker.com

**KZ** – Kazakhstan, Almaty  
Tel: +7 7273 561 000  
parker.easteurope@parker.com

**NL** – The Netherlands, Oldenzaal  
Tel: +31 (0)541 585 000  
parker.nl@parker.com

**NO** – Norway, Stavanger  
Tel: +47 66 75 34 00  
parker.norway@parker.com

**PL** – Poland, Warsaw  
Tel: +48 (0)22 573 24 00  
parker.poland@parker.com

**PT** – Portugal, Leca da Palmeira  
Tel: +351 22 999 7360  
parker.portugal@parker.com

**RO** – Romania, Bucharest  
Tel: +40 21 252 1382  
parker.romania@parker.com

**RU** – Russia, Moscow  
Tel: +7 495 645-2156  
parker.russia@parker.com

**SE** – Sweden, Spånga  
Tel: +46 (0)8 59 79 50 00  
parker.sweden@parker.com

**SK** – Slovakia, Banská Bystrica  
Tel: +421 484 162 252  
parker.slovakia@parker.com

**SL** – Slovenia, Novo Mesto  
Tel: +386 7 337 6650  
parker.slovenia@parker.com

**TR** – Turkey, Istanbul  
Tel: +90 216 4997081  
parker.turkey@parker.com

**UA** – Ukraine, Kiev  
Tel: +48 (0)22 573 24 00  
parker.ukraine@parker.com

**UK** – United Kingdom, Warwick  
Tel: +44 (0)1926 317 878  
parker.uk@parker.com

**ZA** – South Africa, Kempton Park  
Tel: +27 (0)11 961 0700  
parker.southafrica@parker.com

### ! CAUTION !

Do not mix or interchange component parts or tubing with those of other manufacturers. Doing so is unsafe and will void warranty.

Parker Autoclave Engineers Valves, Fittings, and Tools are not designed to interface with common commercial instrument tubing and are designed to only connect with tubing manufactured to Parker Autoclave Engineers AES specifications. Failure to do so is unsafe and will void warranty.

### WARNING

FAILURE, IMPROPER SELECTION OR IMPROPER USE OF THE PRODUCTS AND/OR SYSTEMS DESCRIBED HEREIN OR RELATED ITEMS CAN CAUSE DEATH, PERSONAL INJURY AND PROPERTY DAMAGE.

This document and other information from Parker Hannifin Corporation, its subsidiaries and authorized distributors provide product and/or system options for further investigation by users having technical expertise. It is important that you analyze all aspects of your application and review the information concerning the product or system in the current product catalog. Due to the variety of operating conditions and applications for these products or systems, the user, through its own analysis and testing, is solely responsible for making the final selection of the products and systems and assuring that all performance, safety and warning requirements of the application are met. The products described herein, including without limitation, product features, specifications, designs, availability and pricing, are subject to change by Parker Hannifin Corporation and its subsidiaries at any time without notice.

### Offer of Sale

The items described in this document are available for sale by Parker Hannifin Corporation, its subsidiaries or its authorized distributors. Any sale contract entered by Parker will be governed by the provisions stated in Parker's standard terms and conditions of sale (copy available upon request).



Instrumentation Products Division  
Autoclave Engineers Operation  
8325 Hessinger Drive  
Erie, PA 16509-4679  
Tel: 814 860 5700  
Fax: 814 860 5811  
[www.autoclave.com](http://www.autoclave.com)  
[www.parker.com/ipd](http://www.parker.com/ipd)

ISO-9001 Certified

Instrumentation Products Division  
Division Headquarters  
1005 A Cleaner Way  
Huntsville, AL 35805 USA  
Tel: 256 881 2040  
Fax: 256 881 5072

Parker Hannifin Manufacturing Ltd.  
Instrumentation Products Division,  
Europe  
Riverside Road  
Pottington Business Park  
Barnstaple, UK, EX31 1NP, UK  
Tel: 44 1271 313131  
Fax: 44 1271 373636